

Всеукраїнський науково-технічний журнал

Ukrainian Scientific & Technical Journal

ISSN 2306-8744

DOI: 10.37128/2306-8744-2022-4

Вібрації в техніці та технологіях



Всеукраїнський науково-технічний журнал
Ukrainian Scientific & Technical Journal

Вібрації в техніці та технологіях

№ 4 (107)

Вінниця 2022

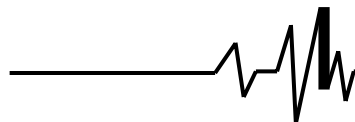
**ВІБРАЦІЇ В
ТЕХНІЦІ ТА
ТЕХНОЛОГІЯХ**

Журнал науково-виробничого та навчального
спрямування Видавець: Вінницький національний
аграрний університет

Заснований у 1994 році під назвою “Вібрації в техніці та
технологіях”

Свідоцтво про державну реєстрацію засобів масової
інформації

КВ № 16643-5115 ПР від 30.04.2010 р.

Всеукраїнський науково-технічний журнал “Вібрації в техніці та технологіях” / Редколегія: Калетнік Г.М. (головний редактор) та інші. – Вінниця, 2022. – 4 (107) – 103 с.

Друкується за рішенням Вченої ради Вінницького національного аграрного університету (протокол № 6 від 23.12.2022 р.)

Періодичне видання включено до Переліку наукових фахових видань України з технічних наук (Категорія «Б» Наказ Міністерства освіти і науки України від 02.07.2020 р. № 886)

Головний редактор

Калетнік Г.М. – д.е.н., професор,
академік НААН України, Вінницький
національний аграрний університет

**Заступник головного
редактора**

Адамчук В.В. – д.т.н., професор, академік
НААН України, Національний науковий
центр “Інститут механізації та електрифікації
сільського господарства”

Відповідальний секретар

Солона О.В. – к.т.н., доцент, Вінницький
національний аграрний університет

Члени редакційної колегії

Булгаков В.М. – д.т.н., професор, академік
НААН України, Національний університет
біоресурсів і природокористування України

Граняк В.Ф. – к.т.н., доцент, Вінницький
національний аграрний університет

Деревенько І. А. – к.т.н., доцент,
Національний університет «Львівська
політехніка»

Зіньковський А.П. – д.т.н., професор,
Інститут проблем міцності імені Г. С.
Писаренка НАН України

Купчук І.М. – к.т.н., доцент, Вінницький
національний аграрний університет

Матвєєв В.В. – д.ф.-м.н., професор,
академік НАН, Інститут проблем міцності
імені Г.С. Писаренка НАН України

Полєвода Ю.А. – к.т.н., доцент, Вінницький
національний аграрний університет

Севостьянов І.В. – д.т.н., професор,
Вінницький національний аграрний
університет

Твердохліб І.В. – к.т.н., доцент, Вінницький
національний аграрний університет

Токарчук О.А. – к.т.н., доцент, Вінницький
національний аграрний університет

Цуркан О.В. – д.т.н. доцент, Вінницький
національний аграрний університет

Зарубіжні члени редакційної колегії

Максімов Джордан Тодоров – д.т.н., проф., Технічний Університет Габрово (Болгарія)

Технічний редактор **Мельничук С.В.**

Адреса редакції: 21008, Вінниця, вул. Сонячна 3, Вінницький національний аграрний
університет, тел. 46 – 00– 03

Сайт журналу: <http://vibrojournal.vsau.org/>

Електронна адреса: vibration.vin@ukr.net

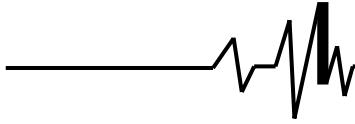
**З М І С Т****1. ТЕОРІЯ ПРОЦЕСІВ ТА МАШИН***Sevostianov I., Ivanchuk Y., Kush Y., Volovyk B.***SELECTION OF A RATIONNAL TYPE OF A DRIVE FOR REALIZATION OF CLASSIFICATION PROCESSES OF GRAIN RAW5***Кондратюк Д.Г., Дмитренко В.П.***ОБҐРУНТУВАННЯ ПАРАМЕТРІВ ЕКСТРУДЕНТА З ПРУЖИНИМ ГВИНТОВИМ ЕЛЕМЕНТОМ.....12***Полевода Ю.А., Волинець Є.О., Бистрицький О.П.***МАТЕМАТИЧНА МОДЕЛЬ ЧАСТИНОК В ЦИЛІНДРИЧНОМУ КОНТЕЙНЕРІ ВІБРОЗМІШУВАЧА20***Паладійчук Ю.Б., Телятник І.А.***ТИПИ І КОНСТРУКЦІЇ ВІБРОЗБУДУВАЧІ СУЧАСНОГО МАШИНОБУДУВАННЯ26****2. МАШИНОБУДУВАННЯ ТА МАТЕРІАЛООБРОБКА***Веселовська Н.Р., Романов В.В.***ВИПРОБУВАЛЬНО-ДІАГНОСТИЧНИЙ КОМПЛЕКС ДЛЯ ОБЛАДНАННЯ ТЕПЛИЦЬ36***Strutynskyi S.***THE USE OF ADJUSTABLE DAMPING DEVICES FOR INCREASING TECHNICAL LEVEL OF GROUND ROBOTIC COMPLEXES EQUIPPED WITH A MANIPULATOR.....49***Матвійчук В.А., Савків В.В.***ШТАМПУВАННЯ ОБКОЧУВАННЯ ЗАГОТОВОК З ВИКОРИСТАННЯМ УДОСКОНАЛЕНОГО ЕНЕРГОЕФЕКТИВНОГО ІНДУКЦІЙНОГО НАГРІВАННЯ59***Rubanenko O., Tokarchuk O., Solona O.***SIMULATION OF THE WORK OF PHOTOELECTRIC PLANTS68***Дубчак В.М.***МАТЕМАТИЧНЕ МОДЕЛЮВАННЯ НАПОВНЕННЯ ОБ'ЄМНИХ ГЕОМЕТРИЧНИХ СТРУКТУР РОБОЧИХ ОРГАНІВ БУНКЕРНОГО ТИПУ МАТЕРІАЛАМИ СФЕРИЧНОЇ ФОРМИ75***Віштак І.В.***ВПЛИВ ГЕОМЕТРИЧНИХ ХАРАКТЕРИСТИК ГАЗОВИХ ОПОР НА СТІЙКІСТЬ ВИСОКОШВИДКІСНИХ ШПИНДЕЛЬНИХ ВУЗЛІВ83***Kucherenko J.***ANALISYS OF STUDIES OF MULTIFUNCTIONAL COATINGS FORMATION BY GAS DYNAMIC SPRAYING88***Sevostianov I., Melnyk O., Pidlypna M.***ELABORATION AND RESEARCH OF VIBROSHAKERS WITH ELECTROMAGNETIC DRIVE FOR CLASSIFICATION OF DRY MATERIALS.....94**

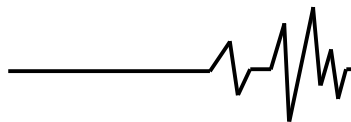
**Sevostianov I.**Doctor of Technical Sciences,
Professor**Vinnytsia National
Agrarian University****Ivanchuk Y.**Doctor of Technical Sciences,
Associate Professor**Kush Y.**

postgraduate student

Volovyk B.

postgraduate student

**Vinnytsia National
Technical University****Севостьянов І. В.**

д.т.н., професор

**Вінницький
національний аграрний
університет****Іванчук Я. В.**

д.т.н., доцент

Куш Я. Ю.

аспірант

Воловик Б. П.

аспірант

**Вінницький
національний
технічний
університет****UDK 621.928****DOI: 10.37128/2306-8744-2022-4-1****SELECTION OF A RATIONAL TYPE
OF A DRIVE FOR REALIZATION OF
CLASSIFICATION PROCESSES OF
GRAIN RAW MATERIALS**

Classification processes (separation, division, sorting) take an important place in food industry where they are used, in particular, for selection of some fractions of grain raw materials (wheat, barley, rye, corn, sunflower, groats) by form, sizes, density or aerodynamic properties of particles of the material or for removal from grain of pollution particles (soil, sand, stones, metallic shaving). The separation processes are quite wide spread in other branches of economy (in chemical, processing, machine building, building, agricultural, metallurgy enterprises), so a task of improvement of classification processes and equipment for their realization is enough actual. Different installations for mechanical classification with unbalanced, hydraulic pulse, pneumatic, electromagnetic, centrifugal drive have reliable design, provide quite stable and effective working process. By our notion, the main working parameters of the mechanical classification of grain raw materials, that determine its efficiency (productivity, specific energy outlay, quality of phase separation) are the maximal speed of movement of the material particles relatively sieve surface and a maximal effort created by the executive element of the installation in the middle of the processed material. Known differential equations of movement and energy balances for determination of these working parameters are complex and unsuitable for elaboration of the engineering method of design calculation of corresponding equipment. So, there are algebraic dependencies for definition of the main working parameters of the mechanical classification under using of basic drives types presented in the article. On the basis of these dependencies, a simple computer program can be compiled to obtain and analyze graphic diagrams that allow to determine the most efficient drive option.

Key words: classification, grain raw material, unbalanced, hydraulic pulse, electromagnetic, centrifugal drive.

Problem formulation. Classification processes (separation, division, sorting) of different dispersive materials are wide spread in food [1], processing, chemical, machine building industry and also in metallurgy, building, agro-industrial complex. There are several methods of classification: by form, sizes, density, electromagnetic or aerodynamic properties of particles of the processed material and corresponding equipment with unbalanced,

hydraulic pulse, pneumatic, electromagnetic, centrifugal drive. In the food and processing industry the classification processes are used for selection of some fractions of grain raw materials (wheat, barley, rye, corn, sunflower, groats) or for removal from grain of pollution particles (soil, sand, stones, metallic shaving) [2 – 7]. By source of an effort, that provides the working classification process, there are mechanical, pneumatic, hydraulic, electro-physical and combined methods

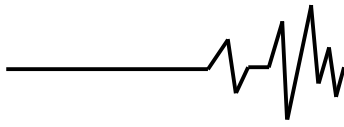

[2 – 7]. One from the most effective by productivity, specific energy outlay, quality of phase separation, reliability of using equipment is the mechanical method. So, the actual problem is an improvement of mechanical classification processes and installations for their realization in direction of decrease of expense of time and energy and provision of necessary qualitative characteristics of the processed material.

Analysis of last researches and publications. Let us more detail examined known theories and approaches for examining of the classification processes, that allow to determine their working and efficiency parameters.

In the works [1, 2] as the main efficiency parameter of a classification process is proposed a ratio of the mass of particles of the processed material with certain dimensions to their mass in the initial mixture. There are experimental data, so this ratio can't be used in a design calculation of an equipment for classification. Also, the work [1] contains formulas for determination of the main working parameters of a sieve with a crank drive and a centrifugal sieve without connection with any efficiency parameters.

Processes of classification of wheat and polystyrene granules with help of a vibration horizontal stepped sieve are researched in the work [3]. In order to determine the main efficiency parameter of the classification process – the speed of vibro-movement of particles of the processed material – the author proposes to use differential equations of movements of the sieve executive element or experimental data. There are more accurate but quite labor-consuming methods. Author researches a classification process in a drum rotating sieve, installed under small angle to the horizontal surface in a field of vertical vibrations. The work contains differential movement equations and formulas for calculation of a hill climbing ability and axial speed of the processed material in the drum sieve, but for definition these parameters there are used experimental data and complex computer programmed means. The same approach there was used for definition of a radial speed of fruits, moving over the surface of a rotating disk of a calibrating machine and a speed of movement of loose material particles over the working surface of rotating conical sieve under additional impact of vertical vibrations. By our notion, the proposed methods of determination of the main working parameters of classification processes demand of improvement for their using as a base for creation of an engineering design calculation method of corresponding equipment.

In the work [4] are presented results of researches of movement of particles of grain raw material along of the surface of a horizontal or an

inclined vibrating sieve with consideration of its structural mechanical characteristics and value of a driving force (a drive of the equipment was not examined in course of this analysis). The corresponding differential equation of the movement and the rheological equation are used for elaboration STAR-CCM+-program, providing receipt of the 3D-diagram for the main efficiency parameters of researched process – classification productivity, distribution of the processed material by fractions, its concentration. The method provides high accuracy the data, that are proved by corresponding experiments, but it characterized by significant labor content. The elaborated equations do not contain working and design parameters of a sieve drive, so the method can't be effectively used in engineering praxis.

Authors of the works [5, 6] propose a resonance structural theory of vibro-transportation processes that by mechanism, main foundations and parameters of efficiency are quite similar with the classification processes [7]. The proposed theory is based on equations of free fluctuations of particles of moving materials under periodical vibro-blowing impacts from the installation's executive element. The theory provides receipt of accurate data about of character particles movement, but demands specialized computer programmed means for realization. Besides, there is absent a connection of the working process parameters with the parameters of the installation drive.

A method presented in the work [8] is realized with help of an experimental installation – a prototype of industrial equipment. The method allows to receive data about of distribution of particles of processed material by mass and sizes, efficiency of the separation depending from particle sizes, but all these experiments demand of significant capital expenses.

The authors of the article [9] conducted researches of efficiency of different schemes of loading of particles of processed material in course of its classification. In order to determine the main efficiency parameter – specific energy consumption for movement of a particle of material in course of the classification process there were used differential equations of movement and energy balances. The method is simpler, than the previous ones, but demands for realization of corresponding universal software (Mathcad, Matlab Simulink ets) and significant expenses of time. So, the task of improvement of theory and research methods for classification processes of dry grain raw materials is quite actual.

Purpose formulation. elaboration of an engineering calculation method for definition of main working parameters of the mechanical classification of grain raw materials – the maximal

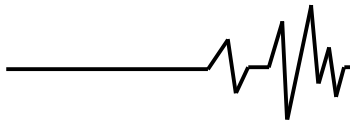

movement speed of particles of processed material relatively sieve's surface and the maximal effort created by the executive element of the installation in the middle of the processed material – under using of various drive types. The method will allow to determine most effective type of drive for realization of classification process in conditions of a concrete production.

Presentation of main material. The main stages of the proposed method are:

- elaboration of structural-calculating schemes of the sieve drives, that will be compared by efficiency;
- receipt of dependencies that connect the main working parameters of the mechanical classification of grain raw materials with drives power;
- calculation of graphic diagrams of the main working parameters of classification depending from design parameters of the drives;
- definition of the most effective type of drive by provided values of the main working parameters.

There are structural-calculating schemes of the sieve with various types of drives presented on the fig. 1.

In case of using of a vibration sieve with the unbalanced drive (fig. 1, a) processing material is fed from the bunker 1 on the surface of the sieve 2, that is hung on springs 3 and makes reciprocal vertical movements, created by the unbalanced vibro-exciter 6. The last are brought into rotation from the electric motors 9 through the elastic couplings 8. As a result, particles of the processed material make movement with the speed v_p under impact of the force F_p . Particles that have less dimensions (fine fraction) go through the sieve 2 and fall in the container 4. Particles with larger dimensions (coarse fraction) move along all of the sieve surface and are unloaded in the container 5.

A working cycle of the sieve 2 fluctuations one can divide into two stages [9]:

- I stage – movement of the sieve from the lower position into the upper position;
- II stage – movement of the sieve from the upper position into the lower position;

In course of the I stage the driving force F_d , created by the unbalanced vibro-exciter 8, is directed upwards, i.e., against of the movement of the particle, so the speed v_p and the force F_p will have minimal values, so there is no necessary to

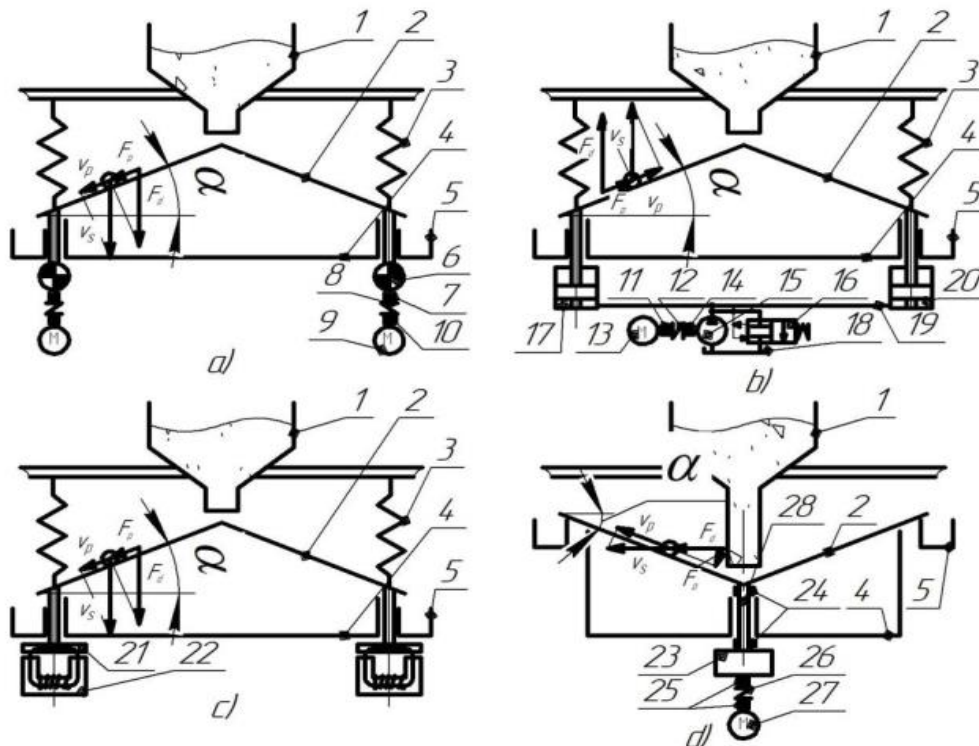
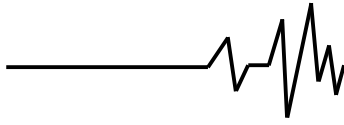

Fig. 1. Structural-calculating schemes of the sieve with various types of drives: a – unbalanced; b – hydraulic pulse; c – electromagnetic; d – centrifugal; 1 – bunker with processed material; 2 – sieve; 3 – springs; 4 – container with fine fraction; 5 – container with coarse fraction; 6 – unbalanced vibro-exciter; 7, 10, 11, 14, 24, 25 – bearings; 8, 12, 26 – couplings; 9, 13, 27 – electric motors; 15 – pump; 16 – generator of pressure impulses; 17, 20 – hydraulic cylinders; 18 – waste tank; 19 – hydraulic line; 21, 22 – armature and limb of electric magnet; 23 – reduction gear unit; 28 – shaft



determine them for evaluation of the drive's efficiency.

In course of the II stage the maximal value of the speed v_p we can determine depending from the maximal value of the sieve speed v_s , that can be calculated as

$$v_p = v_{s,max} \sin \alpha = \omega_u r_u \sin \alpha, \quad (1)$$

where ω_u – circular frequency of rotation of the executive elements of the unbalanced vibro-exciter 6; r_u – radius of installation of the executive elements; α – angle of the sieve working surface to horizontal surface.

With consideration of the known formula

$$\omega_u = \frac{\pi n_u}{30}, \quad (2)$$

where n_u – linear frequency of rotation of the executive elements, the formula (1) can be also presented as

$$v_p = \frac{\pi n_u r_u \sin \alpha}{30}. \quad (3)$$

We can determine the maximal value of the force F_p depending from the maximal value of the driving force F_d , that, with taking into account of the formula (2), can be calculated as

$$F_p = F_{d,max} \sin \alpha = m_u k_u \omega_u^2 r_u \sin \alpha = \frac{m_u k_u \pi^2 n_u^2 r_u \sin \alpha}{900}, \quad (4)$$

where m_u – mass of one executive element; k_u – number of the executive elements.

The speed $v_{s,max}$ and the force $F_{d,max}$ are related with power of the electric motor 9 - N_m of the sieve's drive by the ratio

$$N_m = \frac{F_{d,max} v_{s,max}}{\eta_m \eta_c \eta_b^2}, \quad (5)$$

where η_m, η_c, η_b – coefficients of efficiency of motor 9, coupling 8 and bearings 7, 10.

So, with consideration of the formula (5) the dependencies (1) and (4) can be presented also as

$$v_p = \frac{N_m \eta_m \eta_c \eta_b^2 \sin \alpha}{F_{d,max}} = \frac{900 \cdot N_m \eta_m \eta_c \eta_b^2 \sin \alpha}{m_u k_u \pi^2 n_u^2 r_u}; \quad (6)$$

$$F_p = \frac{N_m \eta_m \eta_c \eta_b^2 \sin \alpha}{v_{s,max}} = \frac{30 \cdot N_m \eta_m \eta_c \eta_b^2 \sin \alpha}{\pi n_u r_u}. \quad (7)$$

Reciprocal vertical movements of sieve 2 with a hydraulic pulse drive (look fig. 1, b) provide hydraulic cylinders 17, 20. Their rods are connected with the sieve 2 and the head ends through the hydraulic line 19 – with the pump 15. The drive of the pump provides the electric motor 13 through the coupling 12. The generator impulses of pressure (GIP) 16 is linked up to the head cavity of the pump 15 by the scheme “in exit” [10] and provide an automatic periodical connection of the cavity with the waste tank 18. The working cycle of the hydraulic pulse pressure drive of the sieve can be divided into two stages [10]:

- I stage under closed GIP (left position by the scheme): increase of pressure in head ends of the hydraulic cylinders 17, 19 from the minimal value p_2 to the maximal value p_1 , movement of the cylinder's

rods and the sieve 2 from the lower into the upper position [11];

- II stage under opened GIP (right position by the scheme): decrease of pressure in head ends of the hydraulic cylinders 17, 19 [12] from the maximal value p_1 to the minimal value p_2 , movement of the cylinder's rods and the sieve 2 from the upper into the lower position.

The maximal values of the speed v_p and the force F_p will take place in course of the I stage of the drive's working cycle

$$v_p = v_{s,max} \sin \alpha = \frac{Q_p \sin \alpha}{S_p n_c}; \quad (8)$$

$$F_p = F_{d,max} \sin \alpha = p_1 S_p k_c \sin \alpha, \quad (9)$$

where Q_p – pump 15 capacity; S_p – cross-section area of the drive's hydraulic cylinder; k_c – number of the cylinders [13].

The capacity Q_p and the pressure p_1 are related with the power of the electric motor 13 by the formula [11]

$$N_m = \frac{Q_p p_1}{\eta_m \eta_p \eta_c \eta_{cl} \eta_b^2}, \quad (10)$$

where $\eta_m, \eta_p, \eta_c, \eta_{cl}, \eta_b$ – coefficients of efficiency of motor 13, pump 15, coupling 12, hydraulic cylinder 17 and bearings 11, 14.

With consideration of the formula (10) the dependencies (8, 9) can be presented also as

$$v_p = \frac{N_m \eta_m \eta_p \eta_c \eta_{cl} \eta_b^2 \sin \alpha}{S_p n_c p_1}; \quad (11)$$

$$F_p = \frac{N_m \eta_m \eta_p \eta_c \eta_{cl} \eta_b^2 S_p k_c \sin \alpha}{Q_p}. \quad (12)$$

Under realization of the scheme on the fig. 1, c reciprocal movements of the sieve 2 with processed material provide electromagnetic vibro-exciter. As a result of feeding of voltage the limbs 22 of the electric magnets armatures 21 move down together with the sieve 2, stretching the springs 3 (the I stage of the working cycle of the vibro-exciter) and after cessation of the feeding the armatures 21 with the sieve 2 under impact of the compressed springs are returned in the initial upper position (the II stage of the working cycle of the vibro-exciter) [14]. In case of the periodical voltage feedings the sieve makes reciprocal movements with the frequency ν_d up to 100 Hz and the amplitude A_d up to 4 mm (in most cases under utilization of standard industrial electromagnetic vibro-exciter $\nu_d = 50$ Hz and $A_d = 2$ mm).

There is obvious that in the end of the I stage in the lower point of the sieve movement the value of v_s will be maximal. This value we can find with use of the movement equation

$$\frac{m_s v_s}{t_{wm}} = F_d n_d + m_s g + c_s n_s A_d, \quad (13)$$

where m_s – mass of the sieve 2 with portion of processed material and mass of the armatures 21; t_{wm} – duration of the I stage (movement of the sieve from the upper into the lower position); c_s –

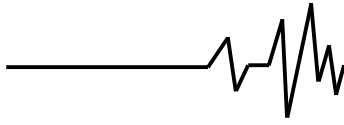

elasticity of the springs 3; n_s - number of the springs; F_d – driving force, creating by one electromagnetic vibro-exciter (one can consider that the value of F_d is constant in course of the I stage); n_d – number of the electromagnetic vibro-exciter [15]. Considering durations of the I and the II stages of a working cycle are approximately equal, one can calculate t_{wm} by the formula

$$t_{wm} = \frac{1}{2}T_d = \frac{1}{2 \cdot v_d}, \quad (14)$$

where T_d – duration of a working cycle of the electromagnetic vibro-exciter.

Then the maximal providing speed v_p of a particle of processed material with using of the formulas (13, 14) can be determined as

$$v_p = v_s \sin\alpha = \frac{t_{wm} \sin\alpha (F_d n_d + m_s g + c_s n_s A_d)}{m_s} = \frac{\sin\alpha (F_d n_d + m_s g + c_s n_s A_d)}{2 \cdot v_d m_s}, \quad (15)$$

And the maximal providing force F_p for the particle, depending from the driving force F_d is

$$F_p = F_d n_d \sin\alpha. \quad (16)$$

Necessary power of the electromagnetic vibro-exciter we can find as

$$N_m = \frac{F_d v_s}{\eta_d}, \quad (17)$$

where η_d – coefficient of efficiency of the electromagnetic vibro-exciter.

In the scheme with the centrifugal drive (look fig. 1, d) the electric motor 27 through the elastic coupling 26 and the reduction gear unit 23 provides continuous rotation of the driving shaft 28 and the sieve 2 with processed material. As a result, its particles move in a direction from axle to periphery of the sieve and that promotes to intensification of the classification process.

In course of movement of a particle of processed material from axle to periphery of the sieve the particle's speed v_p changes from 0 up to the maximal value $v_{p.max}$. So, its average value we can calculate as (look also the formulas (2, 3)

$$v_p = \frac{v_{p.max}}{2} = \frac{v_{s.max} \cos\alpha}{2} = \frac{\pi \cdot n_s r_s \cos\alpha}{60}, \quad (18)$$

where $v_{s.max}$ – maximal peripheral speed of sieve's rotation; n_s – frequency of sieve's rotation; r_s – radius of the sieve.

We can also determine an average value of the force F_p depending from the driving force F_d as (look also the formula (4)

$$F_p = \frac{F_{d.max} \sin\alpha}{2} = \frac{m_m \pi^2 n_s^2 r_s \sin\alpha}{1800}, \quad (19)$$

where m_u – mass of the portion of processed material on sieve's surface.

The speed $v_{s.max}$ and the force $F_{d.max}$ related with power of the electric motor 27 - N_m of the sieve's drive with the ratio

$$N_m = \frac{F_{d.max} v_{s.max}}{\eta_m \eta_c \eta_r \eta_b^4}, \quad (20)$$

where η_m, η_c, η_b – coefficients of efficiency of motor 27, coupling 26, reduction gear unit 23 and the bearings 25, 24.

So, with consideration of the formula (20) the dependencies (18) and (19) can be presented also as

$$v_p = \frac{N_m \eta_m \eta_c \eta_r \eta_b^4 \cos\alpha}{2 \cdot F_{d.max}} = \frac{450 \cdot N_m \eta_m \eta_c \eta_r \eta_b^4 \cos\alpha}{m_m \pi^2 n_s^2 r_s}; \quad (21)$$

$$F_p = \frac{N_m \eta_m \eta_c \eta_r \eta_b^4 \sin\alpha}{2 \cdot v_{s.max}} = \frac{15 \cdot N_m \eta_m \eta_c \eta_r \eta_b^4 \sin\alpha}{\pi \cdot n_s r_s}. \quad (22)$$

Conclusions. 1. In order to select a rational type of drive for sieves and screens and ensure high efficiency of the processes of classifying grain raw materials, engineering methods are needed to calculate the main parameters of efficiency (the speed of a particle of grain raw materials and the force created on it by the executive elements of the equipment) depending on its main design and operating parameters.

2. Known methods for calculating of sieves and screens with the main types of drives (unbalance, hydraulic impulse, electromagnetic, centrifugal) are quite laborious to implement (they require the compilation of complex computer programs and the use of experimental data). In this regard, these methods cannot serve as a basis for creating appropriate engineering calculation methods for choosing of the optimal drive option.

3. The article proposes analytical dependencies to determine the indicated parameters of the efficiency of the processes of classifying dry grain raw materials, depending on the design and operating parameters of sieves and screens with unbalance, hydraulic impulse, electromagnetic, centrifugal drives, which allow with using of simple software tools to calculate the optimal load parameters of grain raw materials for implementation of classification processes and determination of the most efficient option for the equipment drive for classification.

References

- Cherevko, O. I., Poperechny, A. M. (2019) *Procesy i aparaty harchovyh vyrobnychtv [Processes and apparatuses of food productions]* Harkiv.: Svit Knyg [in Ukrainian].
- Boiko, V.S., Samoichuk, K.O., Tarasenko, V.H., Verkholtantseva, V.O., Palianychka, N.O., Mykhailov, Ye.V., Chervotkina, O.O. (2021) *Protsesy i aparaty. Mekhanichni ta hidromekhanichni protsesy [Processes and apparatuses. Mechanical and hydromechanical processes]* Melitopol [in Ukrainian].
- Falko, O.L. (2014) *Naukove obgruntuvannia protsesu fraktsionuvannia roslynnoi syrovyny: [Scientific substantiation of fractioning process of vegetable raw materials.*

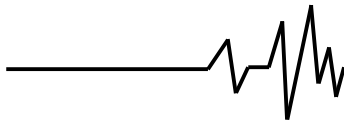

Abstract of D-thesis. Speciality 05.18.12]. Kyiv. [in Ukrainian].

4. Aliiev, E. B. (2019) *Fizyko-matematychni modeli protsesiv pretsyziinoi separatsii nasinnievoho materialu soniashnyku : monohrafiia* [Physical-mathematical models of precise separation processes of sunflower seed grain. Monograph] Zaporizhzhia: STATUS [in Ukrainian].

5. Iskovych-Lototsky, R. D., Ivanchuk, Y. V., Veselovska, N. R., Surtel, W., Sundetov, S. (2018) Automatic system for modeling vibro-impact unloading bulk cargo on vehicles, Proc. SPIE 10808, *Photonics Applications in Astronomy, Communications, Industry, and High-Energy Physics Experiments*. doi: 10.1117/12.2501526.

6. Iskovych-Lototskyi, R. D. Ivanchuk, Ya. V., Veselovskiy, Ya. P. (2014) Osnovy rezonansno-strukturnoi teorii vibroudarnoho rozvantazhennia transportnykh zasobiv [Foundations of resonance structural theory of vibro-blowing unloading of transport means]. *Nauka ta prohres transportu Visnyk Dnipropetrovskoho natsionalnogo universytetu zaliznychnoho transportu im. akademika V. Lazariana. Dnipropetrovsk.*, 5(53). 109-118. doi: 10.15802/stp2014/30458 [in Ukrainian].

7. Sevostianov, I.V., Ivanchuk, Ya.V., Pidlypna, M.P. (2021) Rozrobka variantiv tekhnolohichnykh skhem pererobky osnovnykh vydiv zernovoi syrovyny [Elaboration of variants of technological processing schemes of dry grain row materials]. *Tekhnika, enerhetyka, transport APK*. 4 (115). 128-135 [in Ukrainian].

8. Jarmolik, S.V., Chirkun, D.I., Levdanskiy, A.Je., Levdanskiy, Je.I. (2009) *Jeksperimental'nye issledovanija processa razdelenija sypuchnih materialov v roturno-gravitacionnom klassifikatore. Trudy BGTU [Experimental researches of a separation process of loose materials. Works of BGTU]*, 3, 172-174 [in Russian].

9. Sevostianov, I.V., Melnyk, O.S., Pidlypna, M.P. (2021) Doslidzhennia parametriv efektyvnosti protsesiv klasyfikatsii sukhoi zernovoi syrovyny pry vykorystanni riznykh skhem yii navantazhennia [Researches of efficiency parameters of classification of dry grain row materials under utilization if different schemes of loading]. *Vibratsii v tekhnitsi ta tekhnolohiiakh*. 3(102). 109-117 [in Ukrainian].

10. Sevostyanov I., Ivanchuk Y. (2022) Modelling of working process of equipment with hydraulic drive for separation of damp dispersive materials. *Tekhnika, enerhetyka, transport APK*. 1 (116), 77-82.

11. Sevostianov, I. V. (2020) *Tekhnolohiia ta obladnannia dlia vibroudarnoho znevodnennia volohykh dyspersnykh materialiv : monohrafiia* [Technology and equipment for vibro-blowing

dehydration of damp dispersive materials : monograph] Vinnytsia: VNAU [in Ukrainian].

12. Sevostianov, I., Tokarchuk, O., Pidlypna, M. (2021) Automated technological projection of classification processes of dry dispersive materials [Automated technological projection of classification of dry dispersive materials]. *Tekhnika, enerhetyka, transport APK*. 2 (113). 15-21 [in Ukrainian].

13. Iskovych-Lototsky R., Ivanchuk Y., Veselovska N., Surtel W., Sundetov S. (2018) Automatic system for modeling vibro-impact unloading bulk cargo on vehicles", Proc. SPIE 10808, *Photonics Applications in Astronomy, Communications, Industry, and High-Energy Physics Experiments*. doi: 10.1117/12.2501526.

14. Iskovich-Lototsky R., Kots I., Ivanchuk Y., Ivashko Y., Gromaszek K., Mussabekova A., Kalimoldayev M. (2019) Terms of the stability for the control valve of the hydraulic impulse drive of vibrating and vibro-impact machines. *Przeglad Elektrotechniczny*. Vol. 4, no. 19. P. 19-23. doi: 10.15199/48.2019.04.04.

15. Ivanchuk Y. (2019) Mathematical modeling for the technological process of surface soil compaction by the inertial vibratory rammer. *Academic journal. Series: Industrial Machine Building, Civil Engineering*. Poltava, PoltNTU. 1 (52). P. 15-24. doi: 10.26906/znp.2019.52.1666.

ВИБІР РАЦІОНАЛЬНОГО ТИПУ ПРИВОДУ ДЛЯ РЕАЛІЗАЦІЇ ПРОЦЕСІВ КЛАСИФІКАЦІЇ ЗЕРНОВОЇ СИРОВИНИ

Установки для механічної класифікації зернової сировини з дебалансним, гідроімпульсним, пневматичним, електромагнітним, відцентровим приводом мають надійну конструкцію, значне поширення та забезпечують досить стабільний та ефективний робочий процес. На нашу думку, основними робочими параметрами механічної класифікації зернової сировини, що визначають її ефективність (продуктивність, питомі енерговитрати, якість фазового поділу) є максимальні швидкість руху частинок матеріалу відносно поверхні сита та зусилля, що створюється виконавчим елементом установки в середовищі оброблюваного матеріалу. Відомі диференціальні рівняння руху та балансів енергії для визначення даних робочих параметрів, є складними і непридатними для розробки на їх основі інженерної методики проектного розрахунку відповідного обладнання. У зв'язку із цим, у

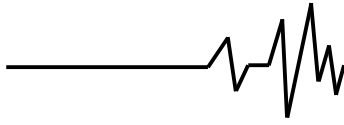

статті представлені алгебраїчні залежності для визначення основних робочих параметрів механічної класифікації при використанні основних типів приводів. На основі цих залежностей може бути складена нескладна комп'ютерна програма для отримання та аналізу графічних діаграм, що дозволяють

визначити найбільш ефективний варіант приводу.

Ключові слова: класифікація, зернова сировина, дебалансний, гідроімпульсний, електромагнітний, відцентровий привод.

Відомості про авторів

Севостьянов Іван Вячеславович – доктор технічних наук, професор, завідувач кафедри «Технологічних процесів та обладнання переробних і харчових виробництв» Вінницького національного аграрного університету (вул. Сонячна, 3, м. Вінниця, 21008, Україна, e-mail: ivansev70@gmail.com).

Іванчук Ярослав Володимирович – доктор технічних наук, доцент, професор кафедри «Комп'ютерних наук» Вінницького національного технічного університету (вул. Хмельницьке шосе, 95, м. Вінниця, Україна, 21021, e-mail: ivanchuck@ukr.net).

Куш Ярослав Юрійович – аспірант Вінницького національного технічного університету (вул. Хмельницьке шосе, 95, м. Вінниця, Україна, 21021).

Воловик Богдан Петрович – аспірант Вінницького національного технічного університету (вул. Хмельницьке шосе, 95, м. Вінниця, Україна, 21021).

Sevostianov Ivan – Doctor of Technical Sciences, Full Professor, Head of the Department of "Technological Processes and Equipment of Processing and Food Productions" of Vinnytsia National Agrarian University (3 Sonyachna St, Vinnytsia, 21008, Ukraine, e-mail: ivansev70@gmail.com).

Ivanchuck Yaroslav – Doctor of Technical Sciences, Associate Professor, Full Professor of the Department "Computer Sciences" of the Vinnytsia National Technical University (95, Khmelnytsky highway, Vinnytsia, 21021, Ukraine, e-mail: ivanchuck@ukr.net).

Kush Yaroslav – Post-Graduate Student of the Vinnytsia National Technical University (95, Khmelnytsky highway, Vinnytsia, 21021, Ukraine).

Volovyk Bohdan – Post-Graduate Student of the Vinnytsia National Technical University (95, Khmelnytsky highway, Vinnytsia, 21021, Ukraine).