

ISSN 1392-1134 (print)/ISSN 2345-0371 (Online)



MCMXXII

VYTAUTAS MAGNUS
UNIVERSITY



AGRICULTURAL ENGINEERING

2022, V 54

**ŽEMĖS ŪKIO
INŽINERIJA**

[HOME](#) [ABOUT](#) [CURRENT ISSUE](#) [ARCHIVES](#) [ANNOUNCEMENTS](#) [EDITORIAL BOARD](#) [AUTHOR GUIDELINES](#) [INDEXING](#) [SEARCH](#) [REGISTER](#)

*Home > About the Journal > **Editorial Board***

Editor-in-Chief

Juozas Padgurskas, Professor, Vytautas Magnus University, Agriculture Academy, Lithuania

Managing Editor

Audrius Zunda, Assoc. prof. Vytautas Magnus University, Agriculture Academy, Lithuania

Editorial Board

Andrei Grigoriev, Dr.Sci. National Academy of Sciences of Belarus, Metal-Polymer Research Institute, Belarus

Gintaras Denafas, Professor, Kaunas University of Technology, Lithuania

Rolandas Domeika, Assoc. prof. Aleksandras Stulginskis University, Lithuania

Thomas Jungbluth, Professor, University of Hohenheim, Germany

Marek Klimkiewicz, Professor, Warsaw University of Life Sciences – SGGW, Poland

Ihor Mykoaliiovych Kupchuk, Vinnytsia National Agrarian University, Ukraine

Violeta Makarevičienė, Professor, Aleksandras Stulginskis University, Lithuania

Hannu Mikkola, University lecturer, University of Helsinki, Finland

Joachim Müller, Professor. University of Hohenheim, Germany

Jüri Olt, Professor, Estonia University of Life Sciences, Estonia

Petras Punys, Professor, Aleksandras Stulginskis University, Lithuania

Algirdas Jonas Raila, Professor, Aleksandras Stulginskis University, Lithuania

Constantinos Dimitrios Rakopoulos, Professor, National Technical University of Athens, Greece

Oleksii Tokarchuk, Vinnytsia National Agrarian University, Ukraine

Egidijus Šarauskis, Professor, Aleksandras Stulginskis university, Lithuania

Kaspars Vartukapteinis, Professor, Latvia University of Agriculture, Latvia

Agricultural Engineering ISSN 1392-1134 / eISSN 2345-0371

This journal is published under the terms of the [Creative Commons Attribution-Noncommercial 3.0 Unported License](#). Responsible editor: Dr A. Žunda.

Table of Contents

Original Articles

GRIKIŲ LUKŠTŲ IR DURPIŲ MIŠINIŲ BLOKURO SAVYBIŲ TYRIMAS	PDF
<i>Miglė Steponavičiūtė, Simona Paulikienė</i>	1-7
DEVELOPMENT OF THE METHODOLOGY AND SUBSTANTIATION OF FUEL SUPPLY PARAMETERS IN THE TRANSITION TO BIOFUEL	PDF
<i>Serhiy Burlaka, Ihor Kupchuk, Ihor Tverdokhlib</i>	8-19
AKTYVIAJA VENTILIACIJA DŽIOVINAMŲ PLUOŠTINIŲ KANAPIŲ SAMPILO TYRIMAI	PDF
<i>Egidijus Zvicevičius*, Šarūnas Petronis*, Martynas Jonaitis**</i>	20-26
INVESTIGATION OF DRIVE POWER OF THE MECHANISM FOR SEPARATION OF STEM FEED FROM FEED MONOLITH	PDF
<i>Serghiy Shargorodskiy, Volodymyr Rutkevych, Ihor Kupchuk, Valerii Hraniak, Andrii Didyk</i>	27-38
USE OF VEGETABLE OILS AS ENVIRONMENTAL ADDITIVES IN DIESEL FUEL	PDF
<i>Serhiy Burlaka, Tetiana Yemchuk, Anatolii Yelenych, Yuliia Okhota</i>	39-48
STUDYING THE DYNAMIC CHARACTERISTICS OF CLOSED SYSTEM OF GRAVITY CONCRETE MIXER'S ELECTRIC DRIVE BY MEANS OF COMPUTER SIMULATION	PDF
<i>Andrii Shtuts, Mykola Kolisnyk, Oleksandr Voznyak</i>	49-61
STUDY OF THE INFLUENCE OF TECHNOLOGICAL PARAMETERS ON THE MECHANICS OF SHAPING OF BILLETS USING ROLL STAMPING PROCESSES	PDF
<i>Andrii Shtuts, Mykola Kolisnyk</i>	62-72

Sharing the experiences

DEVELOPMENT OF A SINGLE ROW ANIMAL DRAWN GROUNDNUT DIGGER FOR SMALLHOLDER GROUNDNUT FARMERS IN SUDAN SAVANNAH OF NIGERIA	PDF
<i>Muhammed Lawal Attanda, Mohammed Shu'aibu Abubakar, Aliyu Idris Muhammad, Aliyu Adinoyi</i>	1-9



STUDY OF THE INFLUENCE OF TECHNOLOGICAL PARAMETERS ON THE MECHANICS OF SHAPING OF BILLETS USING ROLL STAMPING PROCESSES

Andrii Shtuts, Mykola Kolisnyk
Vinnitsa National Agrarian University, Ukraine

Abstract

The article presents the results of development and research of technological schemes of planting flanges on tubular (ring) workpieces by stamping by rolling cylindrical and conical rolls. It is shown that the achievement of significant dimensions of the various elements of the workpiece is possible by providing a directed flow of metal by changing the relative position of the roll and the workpiece. Planting of external flanges is one of the most effective operations of stamping by rolling, as it allows you to form a wide range of products with advanced geometric elements. To assess the technological capabilities of the flange landing operation, the most dangerous from the destruction positions of the workpiece zone was identified and the analysis of the stress-strain state of the material using the method of grids, hardness measurement and microstructural analysis. According to the results of the research, the ways of deformation of the particles of the material of the peripheral surface of the flange in the coordinates "intensity of deformations - an indicator of the stress state" are schematically constructed. These deformation paths are given against the background of curves of ultimate deformations of steels, which are built on the results of uniaxial compression and torsion of cylindrical specimens and using tested approximations. A mathematical model of deformation trajectories is constructed, for which a one-parameter function is taken as a basis, which is "glued" from the elementary function of the sine and tangent to it at some point in the line. To determine the used plasticity resource, a damage summation model with a power approximation of the damage function was adopted. As a result, we have for the first time described the general expression of the linear damage summation model for the case of the parametric deformation path problem. The graphical representation on the constructed model of accumulation of damages in material of a dangerous zone of a flange at landing by a method of rolling stamping (SHO) is resulted. Based on the constructed model, it is possible to model the accumulation of damage by changing the values of the model parameters for different materials and deformation paths, which, in turn, depend on the relative geometric parameters of the workpiece and its location relative to the rolling roll.

Keywords: *rolling stamping (RS), pressure metal treatment (PMT), cold forging rolling stamping, cylindrical and conical rolls, flange landing, stress-strain state, deformability, model of linear summation of damages.*

1. Formulation of the problem

In machine building, rolling stamping (RS) is becoming more commonly used - a method of local plastic treatment under pressure, in which the deformation of the workpiece in the face and at different angles to the longitudinal axis occurs. The localization of the deformation zone and the increased stiffness of the equipment and tools allow us to use this method for processing in a cold state of metals, including steels and alloys of high strength, while ensuring high productivity, the level of resource conservation and the quality of the products obtained [1-4]. PMT processes extend the technological capabilities of low-waste production of high-quality products of complex shape. A special place among the processes of PMT take the methods of local deformation, in particular rolling stamping. The insignificant contact area of the tool with the workpiece causes relatively small forces of deformation, and favorable conditions of the flow of material in the contact zone contribute to the formation of developed tubular, cylindrical elements of preforms of complex shape. The versatility of the equipment and the relative ease of tools allow us to use the RS processes to produce a wide range of products. At the same time, the possibility of achieving large deformations is limited to the risk of destruction of the workpieces and loss of stability of their individual parts. An important task is also to

ensure the possibility of producing preforms of a certain shape and size of high quality [2-3]. And the possibility of implementing a variety of deformation schemes make RS quite a promising direction of metal treatment by pressure.

Improvement of RS processes is constrained by the underdeveloped calculating apparatus of the formation mechanics, which is intended to provide: the determination of the kinematics of the flow of metals and the evaluation of the influence of the parameters of technological processes on it; determination of metal ductility; analysis of the stress-strain state and the accumulation of damage in the material of the workpieces; determination of influence of the value of the used plasticity resource on the service characteristics of the products [5-6].

For the solution of this problem a significant input can be made by modern technologies based on methods of treatment of metals by pressure [7]. In the choice of technological processes, equipment, tools and equipment, in addition to technical and economic efficiency, technologists and designers are increasingly interested in the technological capabilities of the processes and their power-supply parameters, which determine the power of the drive of the working mechanisms, overall dimensions, weight of equipment and other parameters.

2. Analysis of recent researches and publications

The study of the deformability of metals is based on the methods of continuum mechanics, mathematical and applied theory of plasticity, phenomenological theory of deformability [8]. To investigate the processes of RS we use the following methods: theoretical (application of the apparatus of analytical geometry, tensor analysis, mathematical analysis) - for the development of mathematical models; experimental - calculation (dividing grids, hardness measurement, microstructural, X-ray diffraction) and numerical (finite element method) - for analysis of the stress-strain state of the workpieces [9].

The methodological basis of the research is the position of mathematical theory of plasticity and mechanics of scattered destruction. To achieve the goal, the following research methods were used: theoretical (analytical geometry, mathematical analysis during the creation and research of mathematical models), experimental (construction of boundary deformation curves during stationary deformation, determination of stress-strain state by the method of coordinate grids, natural experiments under laboratory conditions), experimental-analytical (apparatus of mathematical statistics for the processing of experimental data, approximation of dependencies between component deformations), numerical simulation of deformation processes using complex software DEFORM - 3D [10].

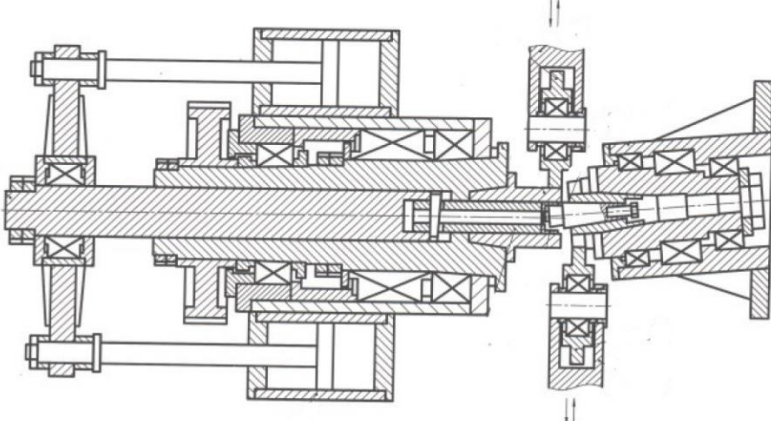

Fig. 1. Prefabrication for implementation of rolling stamping processes.

The technological capabilities of the RS are limited, mainly, to the loss of stability and the destruction of the workpieces, which, in turn, is determined by the direction and intensity of the flow of metal in the workpiece in the contact area with the roll shown in Fig.1. Thus, the possibility of controlling the flow of metal in the workpiece at contact with the roll, is to a large extent determined by the possibility of manufacturing the workpieces of the required shape and dimensions without destroying and losing stability. In the experimental study of the kinematics of the material of the workpiece on contact with the roll, it was established that the direction of such a flow in the contact

area depends on a number of parameters. The main of them is the magnitude and direction of the roll off with respect to the axis of the workpiece, as well as the angle of inclination of the roll α .

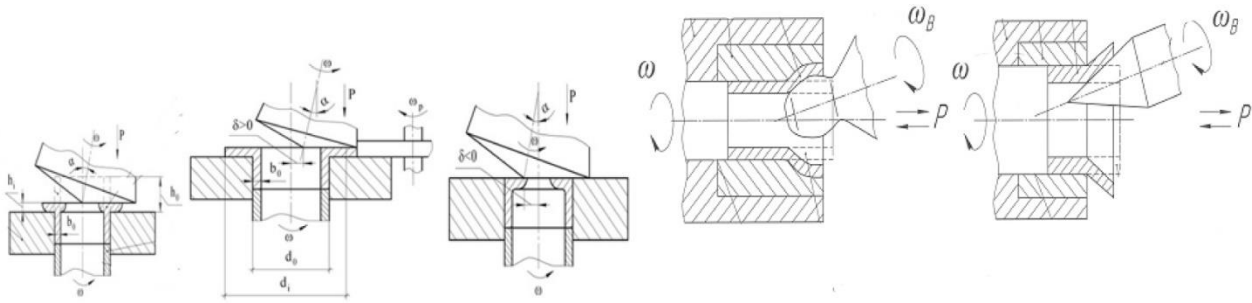

Fig. 2. Influence of the direction of displacement of the peak of the roll of the axis of the workpiece on the shape change of the workpiece during the loading of the clamps by the method of RS

In accordance with the calculations carried out in, with a negative displacement of the roll, material flows to the center of the workpiece, and at a positive - from the center.

The dependence of the angle ψ between the projections of the straight lines, on which the vectors of the velocity of the roll and the workpiece lie on the plane, on the direction and magnitude of the displacement of the roll δ relative to the axis of the workpiece, at different angles of the roller cone, is shown in Fig. 3 [10].

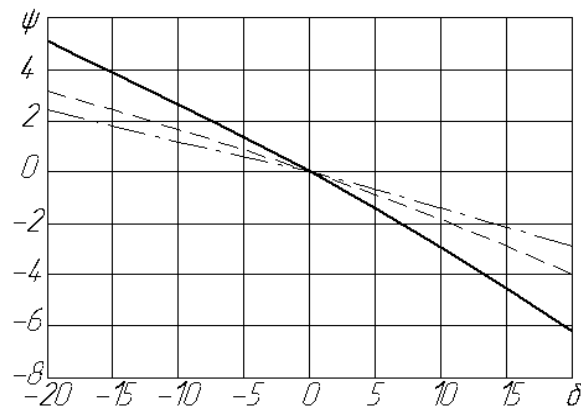

Fig. 3. Dependence of the angle ψ from the direction and the displacement value δ at different angles of the cone: $\alpha = 2^\circ$ (solid line), $\alpha = 10^\circ$ (dashed line), $\alpha = 20^\circ$ (dashed-dotted line).

The obtained analytical dependencies provide a reference point for controlling the flow of metal in a given direction when the tubular blanks are rolled by the schemes of deposition, upsetting, screening, profiling, etc. [8].

A detailed study of the influence of all possible factors on the deformation process by rolling using experimental methods is quite labor-intensive. To the significant shortcomings of theoretical methods of research should include the complexity and even the impossibility of their application to address the noted problem in the RS processes. The disadvantages of these methods are also the inadequacy of the assumptions made by the physical nature of the real processes of local deformation; the necessity of accepting the hypothesis of ideal plasticity or averaging the intensity of stresses in the zone of plastic deformation; the difficulty of taking into account the contact conditions and the correct estimation of the shaping of the workpiece at each stage of rolling.

An alternative to experimental research and theoretical analysis is the use of simulation modelling of RS processes using the finite element method (FEM). [9].

The purpose of this study is to analyze the mechanics of shaping the workpieces by rolling stamping by finite element method and improving on its basis technological processes of RS.

Algorithm for the simulation of through technological processes in software complexes of finite-element modeling of the DEFORM-3D type for the processes of stamping by rolling is presented in Fig.4.

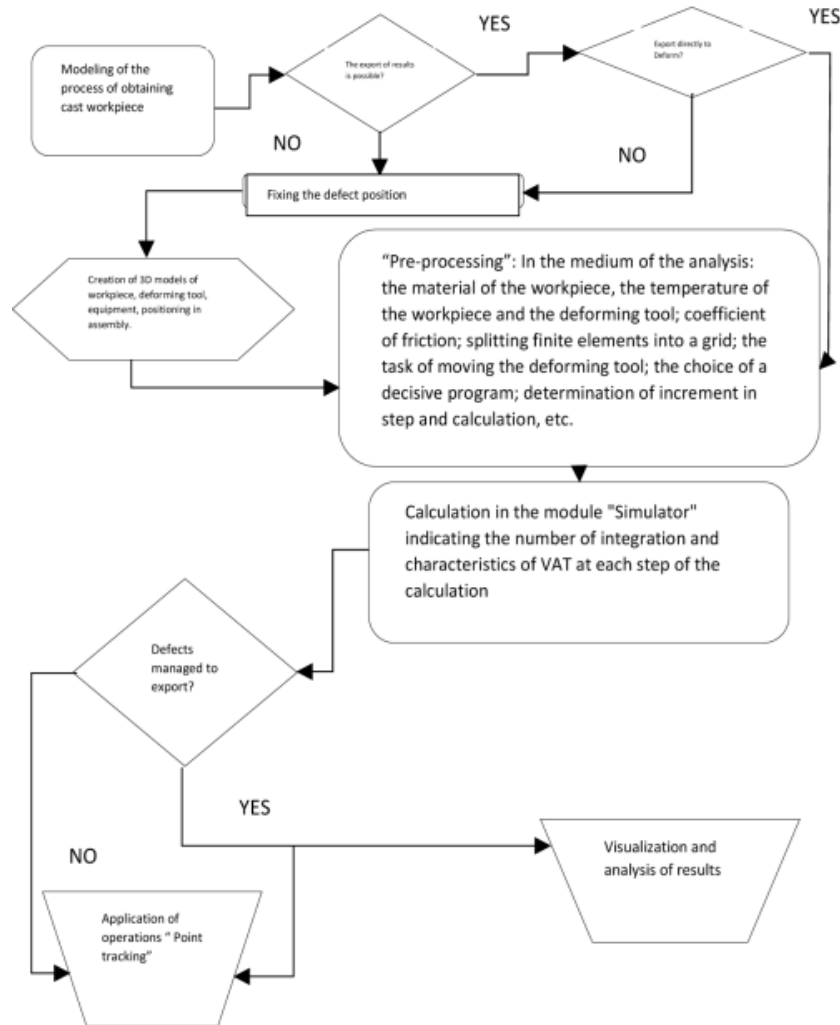

Fig. 4. Algorithm for the simulation of through technological processes in software complexes of finite-element modeling of the DEFORM-3D type

RS was subject to modeling without limitation of the flow of metal along the length of the workpiece. In modeling, the initial mechanical properties for lead were given as follows: Young's modulus 2.1×10^5 MPa, Poisson's coefficient of 0.3 limit of fluidity $\sigma_{0.2} = 6$ MPa. The actual stress diagram was described as a function:

$$\sigma_s = \sigma_i(\varepsilon_i, \bar{\varepsilon}, T), \quad (1)$$

where: $\sigma_{0.2}$ - intensity of stresses; ε_i - intensity of deformations, $\bar{\varepsilon}$ - speed of deformation; T - temperature.

Friction was taken into account on the contact surfaces of the tool and the friction coefficient was set to be $\mu = 0.08$. The deforming tool was taken absolutely rigid.

Fig. 5 shows the calculation scheme of the process of pipe workpiece flanging by RS method where Step-1 and Step-457 are the simulation step.

In the initial position (Fig. 5a) 1) roll, 2) workpiece, 3) movable matrix, which moves with the workpiece in the direction of the roll along the z axis (Fig. 5b).

Computer simulation has determined the current and final geometry of the product, the stress-strain state (SSS) in the deformation center, the use of the resource of plasticity, the distribution of specific forces on the contact surface of the workpiece with the tool, as well as the dependence of the RS's effort on the movement of metal [11].

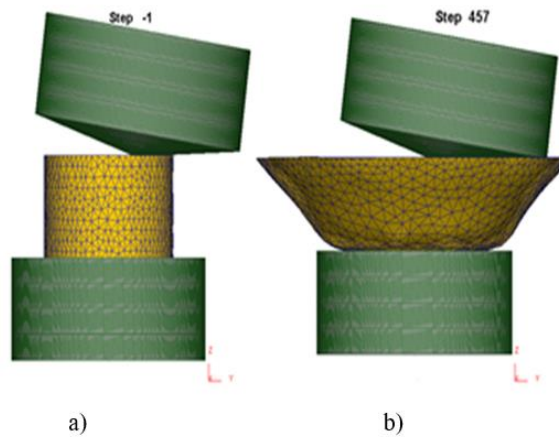

Fig. 5. Scheme of the RS process: a - initial position; b - at the moment of the established stage.

At the intersection of the channel it is visible how much the damage in the places of formation, where $\Psi_i = 0,5 \dots 0,55$ increases. In Fig. 6 the distribution of damage Ψ_i in the volume of deformed metal is shown.

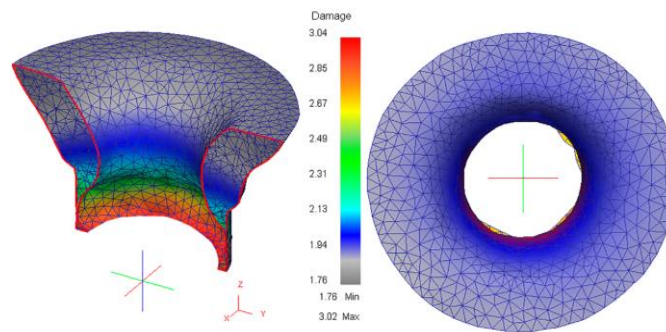

Fig. 6. The distribution of damage Ψ_i in the volume of deformed metal

The maximum value of damage was approximately 0.95 and focuses on the outer surface of the part at the exit [12]. Thus, the simulation showed the possibility to realize the process of forming the profile of the channel by the method of cold plastic deformation without damage.

The distribution of normal contact stresses on the surface of the workpiece at the point of contact with the tool is shown in Fig. 7. The maximum values of normal stresses on the instrument reach 5 MPa on the conical surface and 6 MPa on the mandrel.

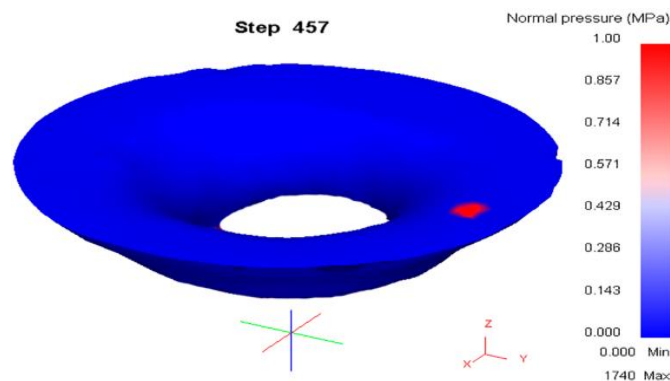

Fig. 7. Distribution of normal stresses on the contact surfaces of the workpiece with the tool

The distribution of stress intensity indicates an unfavorable nature of the stress state: the highest value of the intensity of the stresses reaches the surface layers, forming a solid "skeleton", prevents elasticity after leaving the conical area. The maximum value σ_i in the cell of the deformation of lead was 6 MPa [10].

Calculated dependence of the axial rolling force on the Poisson movement of the punch (roller) is shown in Fig. 8, with the maximum value of the process effort for lead was 25.7 kN.

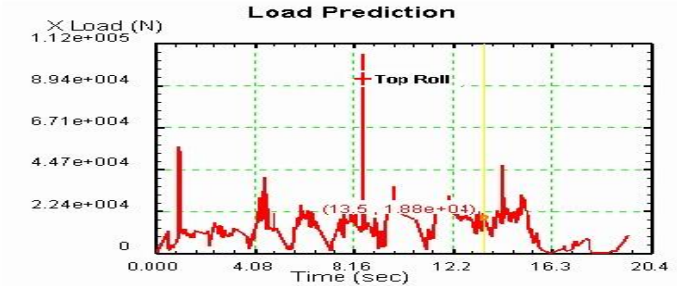

Fig. 8. Dependence of the RS's efforts on the Poisson movement (roller)

The following deformation scheme, which was to be simulated by FEM, was the formation of a profile in the RS process of workpiece on a movable mandrel. The results of simulation are presented in this work, which reflect the filling of the profile as the deformation of the workpiece by a conical roll.

Fig. 9 shows the starting position of the workpiece, when the distance between the workpiece and the roll is maximal. As the area passes through the matrix, this distance decreases (Fig.9b, 9c), and at the final stage, the gap remains only where the centering point was.

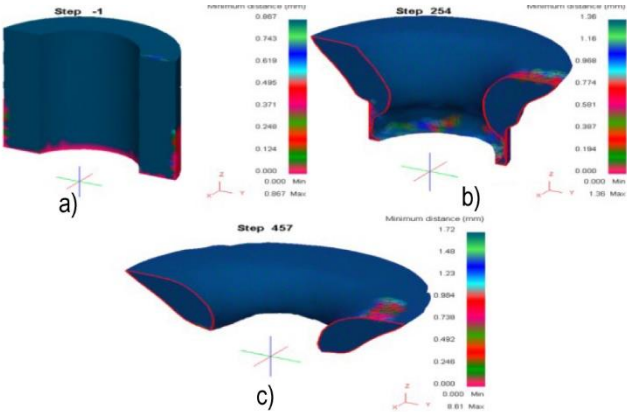

Fig. 9. Changing the maximum distance between the plane of the mandrel and the surface during the stamping process: a - the appearance of the workpiece before the RS; b - the workpiece on the 254 step of the RS process modeling; c - workpiece at the final stage of simulation.

It should be noted that the occipital gaps do not affect the quality of the semi-finished product of the workpiece at all, because they are subject to mechanical processing in these places.

Fig. 10 shows the distribution pattern [6], SSS in the clamp based on the results of the finite element method of RS flanging modeling for the outer ring on the tube workpiece.

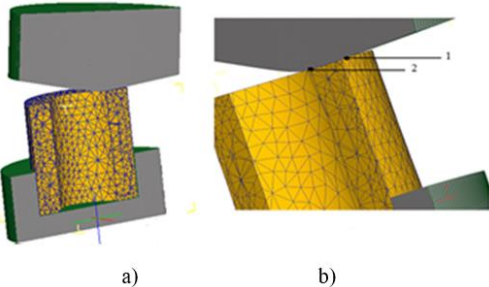

Fig. 10. The finite element method of RS flanging modeling for the outer clamp on the tube workpiece: a) calculation model; b) the location of the calculation points 1 and 2 [11].

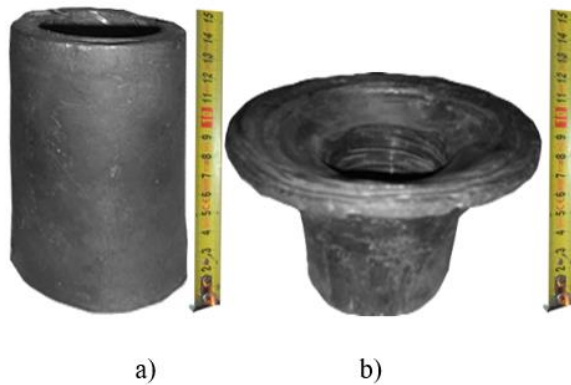

Fig. 11. Lead workpiece № 1 before RS (a) and after RS research (b).

The next RS scheme, which was to be modeled, was the upsetting of the outer clamp on the tube workpiece (Fig. 2 b) [12].

Fig. 12 shows the nature of the formation of the clamp and the distribution of the intensity of deformations ε_i in its cross section.

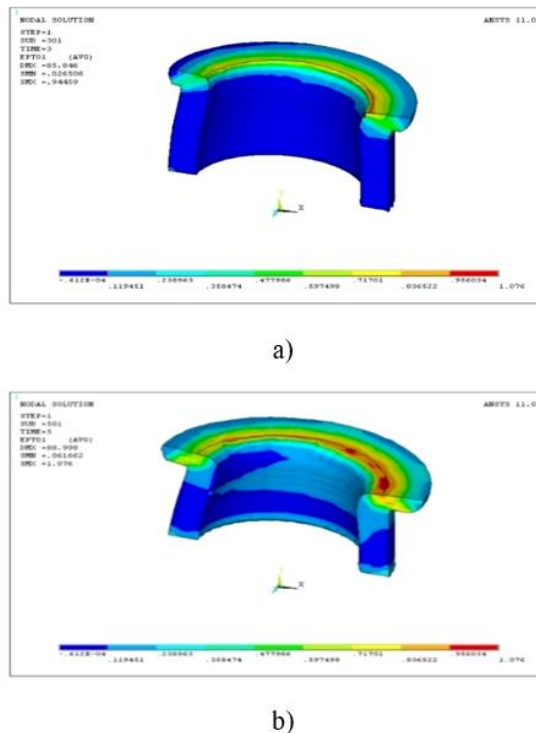

Fig. 12. The nature of the formation of the external clamp and the distribution of the zones of intensity of deformation in it for different degrees of upsetting by rolling a) and b) with arbitrary placement of the workpiece in the matrix.

Fig.13 shows the character of the distribution of the stressed state η in the material of the clamp, where the value of the used σ_i - the plasticity resource Ψ in the metal was determined by the criterion of destruction [5].

$$\psi_i = \int_0^{e_u} \frac{de_u^*}{e_p(\eta, \mu_\sigma)}, \quad (2)$$

where e_p - limiting deformation; $e_p(\eta, \mu_\sigma)$ is the surface of boundary deformations; e_u - the degree of deformation.

$$\eta = \frac{\sigma_x + \sigma_y + \sigma_z}{\sigma_i}, \quad (3)$$

$$\mu_\sigma = \frac{2\sigma_2 - \sigma_1 - \sigma_3}{\sigma_1 - \sigma_3}, \quad (4)$$

η μ_σ – indicators of the stress state of the material

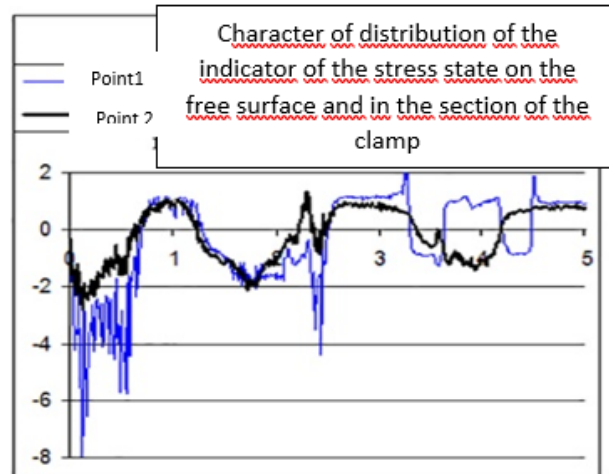

Fig. 13. Distribution of stress components and the stress state on the free surface (point 1) and in the cross section of the clamp (point 2) [5].

Results of application of the method of increasing the accuracy of the determination of boundary conditions during 3D modeling, using the results of experimental and analytical modeling of the SSS of the pipe workpiece in the RS, in accordance with the actual conditions of the form changing, is illustrated in Figs. 14-15. For a visual comparison of the results of the simulation and experimental research, Fig. 14 presents the workpiece during the experiment and as a result of simulation. From the trajectories of deformations presented in Fig. 15, which are constructed in accordance with the results of experimental research and numerical simulation of pipe workpiece, it is clear that the difference between them does not exceed the natural error of scattering of experimental data.

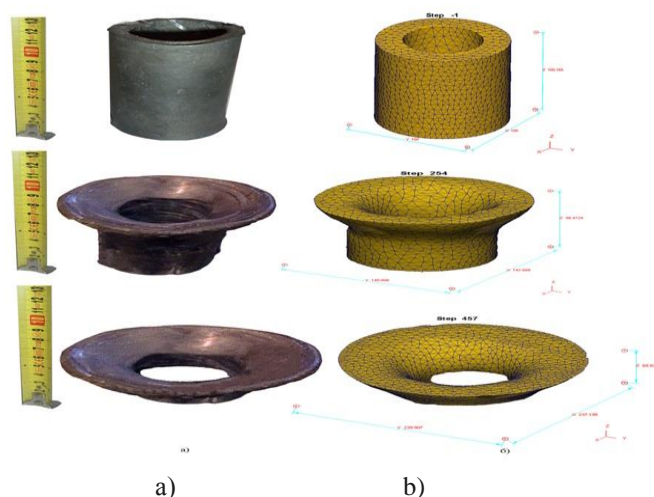

Fig.14 RS of a lead workpiece №5: a) experimental research; b) modeling in DEFORM 3D[7].

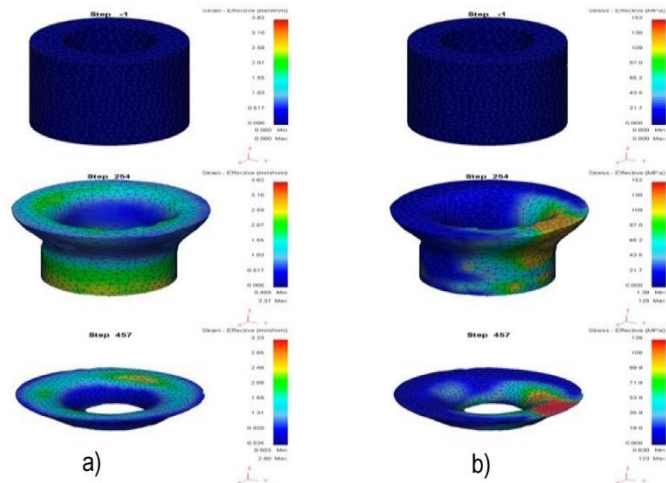

Fig.15 Distribution of accumulated deformation:a) intensity of stresses; b) during modeling of the RS process of lead sample.

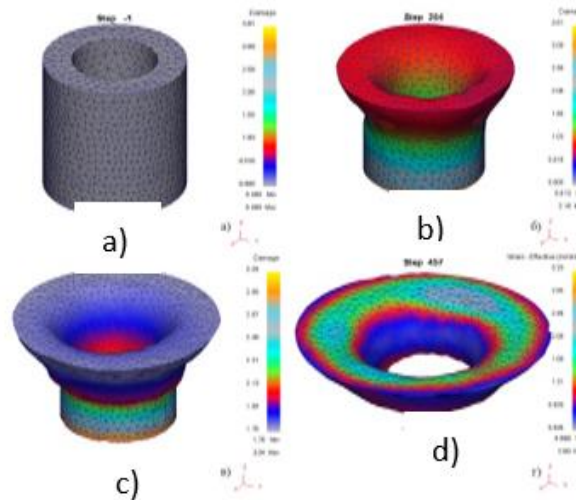

Fig.16 Distribution of accumulation of damages in the volume of pipe workpiece at RS a) initial stage;b) at 254 steps of RS; c) at 320 steps of RS; d) the final step of deformation [7].

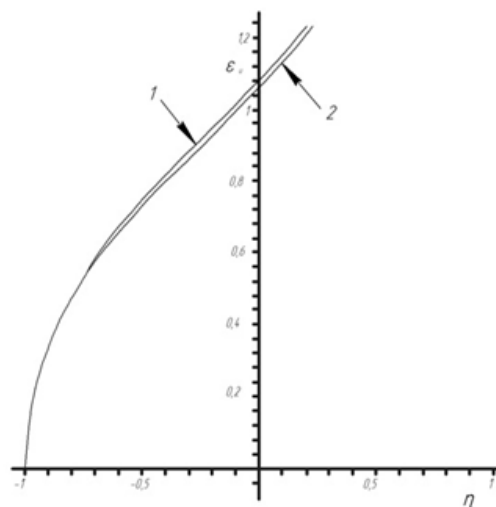

Fig.17 Trajectory of deformation of the lateral surface of lead sample number 5: 1-experimental study; 2- modeling in the software package DEFORM-3D[8]

To obtain and analyze the results of SSS simulation in the meridional section of the sample, they used special commands in the DEFORM -3D postprocessor. The obtained results are presented in Fig. 18.

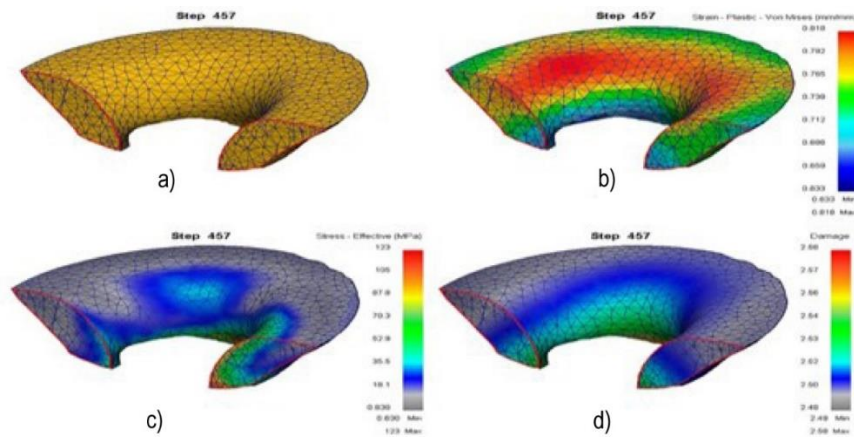

Fig.18 Analysis of VAT modeling results: form change a); distribution in the midinary section of the pipe workpiece at the final stage of the RS accumulated deformation b); intensity of stress in); accumulation of damage d).

The validity of the conducted RS process simulation in accordance with the technological schemes (Fig. 2) was confirmed by the rolling of the workpieces. Fig. 14 shows a part of the workpiece obtained by the RS according to the scheme of upsetting of the external clamp with $\delta > 0$ Fig. 2, b. As can be seen from Fig. 12 and Fig. 14, and the shape of the model is quite consistent with the form of the real detail. Fig. 14 b presents a part of the workpiece deformed with $\delta < 0$, Fig. 2c, in Fig. 14 c, the part of the workpiece was obtained by the RS with the direct extrusion scheme of the deformed with $\delta = 0$, Fig. 2, a.

Experimental methods, such as grid method and hardness measurements, also confirmed the corresponding definition of the SSS by simulation.



Fig. 19. Workpieces obtained by RS method.

The obtained values of the intensity of deformations and the index of the stress state allow using the criterion (2) to evaluate the deformability of the workpiece when upsetting by the RS method of external clamps for different materials [12].

3. Conclusions

1. The effect on the technological parameters of the mechanics of the formation of blanks was studied and computer modeling of the rolling stamping process was carried out using the DEFORM 3D software complex.

2. The model determines the parameters of the use of the plasticity resource, the final geometry of the product, the distribution of specific forces on the contact surface of the workpiece with the tool. What is confirmed by modeling the process with physical samples.

3. The dependence of the force applied to the workpiece during the process on the movement of the material is determined. The maximum damage value was approximately 0.95 and was concentrated on the outer surface of the part.

References

- [1]. Ogorodnikov V.A. (1983). Estimation of deformability of metals during pressure treatment. Kyiv: *Higher school*. C. 175. [in Ukrainian].
- [2]. V.A. Matviychuk., I.S. Aliev. (2009). "Improvement of processes of local rotational processing by pressure on the basis of the analysis of deformability of metals". Kramatorsk: DGMA. *Monograph*. [in Ukrainian].
- [3]. Gozhiy S.P., Krivda L.T. (2006). Stamping by rolling as a means of resource conservation. *Scientific news of the National Technical University of Ukraine "Kyiv Polytechnic Institute"*. № 2 (46). Pp. 55-60. [in Ukrainian].
- [4]. Kraievskiy V. O., Matviychuk, V. A., Mykhalevych, V. M. (2003). Vplyv tekhnolohichnykh parametriv na kinematyku kholodnoho tortsevoho rozkochuvannya. *Udoskonalennia protsesiv ta obladnannia obrobky tyskom v mashynobuduvanni i metalurhii*. Kramatorsk - Sloviansk. 286-291. [in Ukrainian].
- [5]. Matviychuk V.A., Mikhalevich V.M., Kolisnyk M.A. (2022). Estimation of deformability of material of preparations at direct and return extrusion by a method of stamping by rolling. *Vibrations in engineering and technology*. №1 (104). Pp. 81-91. [in Ukrainian].
- [6]. Matviychuk V.A., Kolisnyk M.A., Shtuts A.A. (2018). Investigation of the stress-strain state of the workpiece material during direct extrusion by rolling stamping. *Engineering, energy, transport of agro-industrial complex*. № 3 (102). 77-84. [in Ukrainian].
- [7]. Mikhalevich V.M. (1998). Tensor models of damage accumulation. Vinnytsia: "*UNIVERSUM - Vinnytsia*". S. 195. [in Ukrainian].
- [8]. A. Shtuts, M. Kolisnyk, V. Yavdyk. (2018). Improvement of processes of rolling stamping on the basis of investigation of technological parameters on the mechanics of workpieces formation. *MOTROL. Commission of Motorization and Energetics in Agriculture*. P. 19-25. [in Poland].
- [9]. Gundebommu L., Matviychuk V., Rubanenko O., Branitskiy Yu. (2021). Justification and development of methods building curves boundary deformation of metals. *Materials Today: Proceedings*. 38, pp. 3337–3344.
- [10]. Viktor Matviychuk., Andrii Shtuts., Mykola Kolisnyk., Ihor Kupchuk., Iryna Derevenko. (2022). Investigation of the Tubular and Cylindrical Billets Stamping by Rolling Process with the Use of Computer Simulation. *Periodica Polytechnica, Mechanical Engineering*. №1 (66), P. 51–58. [in Hungary].
- [11]. Kupchuk I., Kolisnyk M., Shtuts A., Paladii M. (2021). Development of the technological process of forming rings from sheet samples by stamping rollers and rotary hood. *Bulletin of the Transilvania University of Braşov. Series I: Engineering Sciences*. Vol. 14 (63), № 2. P. 1-13. [in Romania].
- [12]. Karnaukh S.G., Aliyev I.S., Matviychuk V.A., Tagan L.V. (2021). Development of dies with a differential clamp for cutting workpieces for precision stamping. *Engineering, energy, transport of agro-industrial complex*. №4 (115). Pp. 66-74. [in Ukrainian].

Authors for contact:

Shtuts Andrii, Assistant,

Department of Electric Power Engineering, Electrical Engineering and Electromechanics,
Vinnitsa National Agrarian University
3, Solnechna str., Vinnitsa, 21008, Ukraine,
email: shtuts1989@gmail.com, <https://orcid.org/0000-0002-4242-2100>).

Kolisnyk Mykola, Assistant,

Department of Electric Power Engineering, Electrical Engineering and Electromechanics,
Vinnitsa National Agrarian University
3, Solnechna str., Vinnitsa, 21008, Ukraine,
email: kolisnik30@gmail.com, <https://orcid.org/0000-0001-5502-6556>).