



**MODERNIZATION OF RESEARCH AREA:  
NATIONAL PROSPECTS  
AND EUROPEAN PRACTICES**

Scientific monograph

Riga, Latvia  
2022

UDK 001(08)  
MO045

**Title:** Modernization of research area: national prospects and European practices

**Subtitle:** Scientific monograph

**Scientific editor and  
project director:**

Anita Jankovska

**Authors:** Nataliia Pinchuk, Oleksandr Terletskiy, Yuliia Aleskerova, Lidia Fedoryshyna, Liudmyla Boltovska, Kateryna Burko, Sergii Ivanov, Natalya Osadchaya, Hanna Razumova, Olesia Lemishovska, Dmytro Sopov, Tetiana Karpenko, Andrii Sryberko, Serhiy Burlaka, Tetiana Yemchik, Serhiy Burlaka, Natalia Telekalo, Julia Poberezhets, Mykhailo Zamrii, Olena Solona, Ihor Kupchuk, Ihor Tverdokhlib, Yurii Polievoda, Vitalii Yaropud, Inna Honcharuk, Pavlo Leontiev, Inna Torianyuk, Svitlana Kalinichenko, Oksana Starishko, Olha Voronkova, Olha Voronkova, Yuliia Voronkova, Taisiya Shevchenko, Svitlana Koshova, Artem Androsenko, Ljudmila Dovbnia, Petro Dovbnia, Kateryna Kovalova, Tetiana Ponomarenko, Tetiana Shynkar, Svitlana Kaleniuk, Iryna Loshchenova, Marta Karp, Lyudmila Maystrenko, Anzhelika Solodka, Tatiiana Moroz, Oksana Sinenko

**Publisher:** Publishing House “Baltija Publishing”, Riga, Latvia

**Available from:** <http://www.baltijapublishing.lv/omp/index.php/bp/catalog/book/234>

**Year of issue:** 2022

All rights reserved. No part of this book may be reprinted or reproduced or utilized in any form or by any electronic, mechanical, or other means, now known or hereafter invented, including photocopying and recording, or in any information storage or retrieval system, without permission in writing from the publisher and author.

Modernization of research area: national prospects and European practices: Scientific monograph. Riga, Latvia: Baltija Publishing, 2022. 712 p.

ISBN: 978-9934-26-221-0

DOI: <https://doi.org/10.30525/978-9934-26-221-0>

The scientific monograph presents the theoretical and practical aspects of the modernization of research area: national prospects and European practices. General questions of economics and enterprise management, technical sciences, technology of food and light industry, physical and mathematical sciences, geographical sciences, medical sciences, legal sciences, national security issues, pedagogical and philological sciences, and so on are considered. The publication is intended for scientists, educators, graduate and undergraduate students, as well as a general audience.

© Izdevniecība “Baltija Publishing”, 2022  
© Authors of the articles, 2022

## Table of Contents

### CHAPTER «PHYSICAL AND MATHEMATICAL SCIENCES»

*Nataliia Pinchuk, Oleksandr Terletskyi*

NANOSTRUCTURED COATINGS ZRN, OBTAINED  
BY VACUUM-ARC DEPOSITION METHOD. . . . . 1

### CHAPTER «ECONOMIC SCIENCES»

*Yuliia Aleskerova, Lidiia Fedoryshyna*

HEALTH INSURANCE, PROSPECTS OF DEVELOPMENT IN UKRAINE. . . . . 19

*Liudmyla Boltovska*

CURRENT TRENDS IN THE DEVELOPMENT  
OF THE MEAT PRODUCT SUBCOMPLEX OF UKRAINE  
IN THE CONTEXT OF EUROPEAN INTEGRATION. . . . . 52

*Kateryna Burko*

METHODS OF TRAINING OF ACCOUNTING SPECIALISTS  
IN THE CONDITIONS OF DISTANCE EDUCATION. . . . . 87

*Sergii Ivanov, Natalya Osadchaya, Hanna Razumova*

STRATEGIC DIRECTIONS  
OF UKRAINE'S EXPORT STRATEGY FORMATION. . . . . 108

*Olesia Lemishovska*

CAPITAL IN ACCOUNTING WORKS OF SCIENTISTS  
OF GALICIA IN THE SECOND HALF OF THE XIX –  
MIDDLE OF THE XX CENTURY: RETROSPECTIVE ANALYSIS  
AND EVALUATION FROM THE POSITION OF MODERN LANDMARKS. . . . . 139

### CHAPTER «GEOGRAPHICAL SCIENCES»

*Dmytro Sopov, Tetiana Karpenko*

GEOSPATIAL FEATURES OF LAND USE AND NATURAL PREREQUISITES  
FOR LAND DEVELOPMENT IN LUHANSK REGION (UKRAINE). . . . . 161

*Andrii Sryberko*

CALCULATION OF THE VERTICAL DISTRIBUTION  
OF THE SPEED OF SOUND IN THE BLACK SEA BASED  
ON SATELLITE DATA IN THE PERIOD SPRING – AUTUMN 2021. . . . . 184

**CHAPTER «AGRICULTURAL SCIENCES»**

*Serhiy Burlaka, Tetiana Yemchik*

IMPROVING THE EFFICIENCY OF THE USE OF BIODIESEL  
FUEL MIXTURES IN THE SYSTEMS OF AUTONOMOUS ENERGY  
SUPPLY OF AGRICULTURAL ENTERPRISES . . . . . 205

*Serhiy Burlaka, Natalia Telekalo*

MODERNIZATION OF THE POWER SUPPLY SYSTEM  
OF A DIESEL POWER PLANT . . . . . 238

*Julia Poberezhets, Mykhailo Zamrii*

EFFICIENCY OF USING A PROBIOTIC FEED ADDITIVE  
IN FEEDING KURCHAT BROILERS . . . . . 270

*Olena Solona, Ihor Kupchuk*

DEVELOPMENT OF A FUNCTIONAL MODEL OF A VIBRATING MILL  
WITH ADAPTIVE CONTROL SYSTEM OF MODE PARAMETERS . . . . . 302

*Ihor Tverdokhlib, Yurii Polievoda*

THE INFLUENCE OF PARAMETERS OF RUNNING SYSTEMS  
AND THEIR SUSPENSION ON THE SAFETY OF OPERATORS  
OF MOBILE MACHINES AND ENERGY EQUIPMENT . . . . . 329

*Vitalii Yaropud, Inna Honcharuk*

DEVELOPMENT AND JUSTIFICATION OF CONSTRUCTIVE-REGIME  
PARAMETERS OF THE AUTOMATED SYSTEM OF MICROCLIMATE  
PROVISION IN APC PREMISES . . . . . 360

**CHAPTER «MEDICAL SCIENCES»**

*Pavlo Leontiev, Inna Torianyk, Svitlana Kalinichenko*

PARAMETERS OF BLOOD AND ERYTHROCYTES AS MARKERS  
OF AGE OF OCCURRENCE OF HEMATOMAS IN LIVING PERSONS . . . . . 390

*Oksana Starishko, Olha Voronkova*

LACTOBACYLLI IN THE MICROBIOTA OF THE REPRODUCTIVE  
TRACT OF WOMEN WHO SMOKE AND DO NOT SMOKE . . . . . 409

**CHAPTER «PHYSICAL EDUCATION AND SPORT»**

*Olha Voronkova, Yuliia Voronkova*

CHONDROMALATION: DIAGNOSIS, TREATMENT, REHABILITATION . . . 433

**DEVELOPMENT AND JUSTIFICATION  
OF CONSTRUCTIVE-REGIME PARAMETERS  
OF THE AUTOMATED SYSTEM  
OF MICROCLIMATE PROVISION IN APC PREMISES**

**Vitalii Yaropud<sup>1</sup>**  
**Inna Honcharuk<sup>2</sup>**

DOI: <https://doi.org/10.30525/978-9934-26-221-0-14>

**Abstract.** The authors' research is aimed at solving current problems of technological renewal and development of the agro-industrial complex of Ukraine.

This research was supported and funded by the Ministry of Education and Science of Ukraine under grant No 0121U108589 «Development of a complex of energy-efficient and resource-saving equipment and promising technologies for feeding farm animals of the AIC of Ukraine».

The efficiency of animal husbandry directly depends on the conditions of keeping animals, in which ensuring an optimal microclimate is extremely important. Thus, the productivity of animals by 10-30% is determined by the microclimate of the premises. Deviation of microclimate parameters from the established limits leads to reduction of milk yield by 10-20%, increase in live weight – by 20-33%, increase in young animals – up to 5-40%, reduction of egg production hens – by 30-35%, the cost of the additional feed, reducing the service life of machinery, equipment and buildings themselves, reducing the resistance of animals to disease. In turn, ensuring an optimal microclimate in livestock facilities is associated with significant costs of heat and electricity, which costs up to 15% of producers. During the heating period, heat generating devices of livestock facilities for various purposes consume up to 90% of the total cost of fuel and energy resources and even a partial reduction of these costs will significantly reduce energy costs for production, and thus reduce its cost. The ever-increasing cost of energy

---

<sup>1</sup> Candidate of Technical Sciences, Associate Professor,  
Vinnytsia National Agrarian University, Ukraine

<sup>2</sup> Doctor of Economics, Professor,  
Vinnytsia National Agrarian University, Ukraine

complicates the situation and exacerbates the problem of implementing energy-saving technologies, as well as highlights the economic problem of reducing specific energy consumption for livestock production.

The purpose of research is to increase the efficiency of the microclimate in pig farms by using an automated control system with reasonable regime parameters. To achieve this goal it is necessary to solve the following tasks: to analyze the technical and technological support of the microclimate in livestock facilities; to carry out research of parameters of a microclimate in a pigsty and identify areas for improvement of the system to ensure it; to determine the influence of design and regime parameters of the automated system of microclimate in the pigsty on its energy efficiency and uniformity of temperature distribution in the building.

The method of theoretical research is mathematical modeling of the process of functioning of the automated system for ensuring the normative parameters of the microclimate in livestock facilities based on the provisions of heat engineering and aerodynamics using numerical calculation methods. The Mathematica computer mathematics system was used to simplify the obtained expressions and mathematical modeling.

### 1. Introduction

One of the factors influencing the efficiency of animal husbandry is the conditions of keeping animals, in which ensuring an optimal microclimate is important.

The microclimate has a significant impact on the efficiency of pork production. Changes in the composition and properties of indoor air can affect the body's reactions. Therefore, in order to improve the health and productivity of animals, as well as to protect against many diseases, it is necessary to take into account changes in the air, their impact on the body and methods of controlling and improving air conditions. Failure to comply with the conditions leads to a violation of temperature homeostasis, reduced productivity, body resistance, disease and even death of animals.

Thus, according to previous studies, the productivity of animals by 5-8% is determined by the microclimate of the premises. All deviations from the normative conditions of the air environment negatively affect the development of the animal and its productivity. In turn, it is known that the traditional provision of optimal microclimate for animals in order to

obtain high productivity from them is associated with high costs of heat and electricity, which costs up to 15% of the funds of producers.

Therefore, the issues of improving automated energy-saving systems in compliance with the optimal conditions of the microclimate in livestock facilities are relevant and require scientific justification.

## **2. Current state of the problem of providing normative parameters of microclimate in animal premises**

### **2.1 Microclimate and its parameters**

The microclimate is determined by the combination of temperature, relative humidity, chemical and mechanical composition of the air. Each of these indicators alone has a significant impact on animal productivity and should be maintained within strict limits, due to the physiological needs and capabilities of animals.

The microclimate is determined by the combination of temperature, relative humidity, chemical and mechanical composition of the air. Each of these indicators alone has a significant impact on animal productivity and should be maintained within strict limits, due to the physiological needs and capabilities of animals.

The microclimate in the premises depends on the local (zonal) climate and season, thermal and moisture resistance of building envelopes, ventilation, lighting and heating, sewerage and manure cleaning quality, technology of keeping animals, their species and age.

The main parameters of the microclimate of livestock facilities are regulated by the norms of technological designing .

The room temperature for breeding boars should be indoors – from 13 °C to 18 °C, for pregnant sows – from 13 °C to 18 °C, for suckling – from 18 °C to 22 °C, for repair young stock – from 18 °C to 22 °C, for weaned piglets up to 30 days – from 24 °C to 30 °C, in 60 days – 22 °C, for piglets on rearing – from 15 °C to 20 °C, for fattening young animals depending on age – from 12 °C to 20 °C. With local heating of piglets in the first week of life, the temperature in the building should be 30 °C, in the second – 28 °C, in the third – 26 °C, in the fourth – 24 °C, in the fifth – 24 °C. Naturally, such parameters of the microclimate at real energy prices require high costs, but these are the most favorable conditions for the life of suckling piglets [1].

At low temperatures the body's heat transfer increases, as a result of which animals consume more food, and at temperatures below the critical temperature, the body does not have time to produce heat from feed energy, hypothermia, possible colds and even death. At temperatures above the critical level, the convective heat exchange of the organism with the environment decreases sharply, so there is a risk of overheating and heat stroke.

In violation of temperature conditions (hypothermia, overheating) there is a decrease in natural resistance and the emergence of pulmonary and gastrointestinal diseases. But sharp fluctuations in temperature during the day have a stronger negative impact on the body than constantly rising or falling temperatures, and this primarily affects the young.

In young farm animals in the first days of life protective humoral factors are poorly developed, the skin and mucous membranes are very sensitive to pathogenic microbes [2].

Humidity of the environment also significantly affects the thermoregulation of the animal's body, and in particular its heat transfer, and high relative humidity (85% and above) has a negative effect on the body and heat transfer at high ambient temperatures and low [24].

High humidity suppresses metabolism and redox processes in the body, reduces the resistance of pigs. When keeping animals in the cold period of the year in rooms with high humidity, diseases such as bronchitis, pneumonia, gastrointestinal diseases in young animals are often observed. High humidity helps to preserve microorganisms in the room, including pathogenic and fungal microflora, which is often the cause of skin diseases – ringworm, eczema, scabies, and others. In addition, at high humidity and low temperatures increases feed consumption per unit of output, animals' appetite deteriorates. Relative humidity from 60% to 70% is optimum, at the raised temperature 50% is admissible, lowered – 80%. Thus, in piggeries with satisfactory feeding of animals, but at high humidity (from 80% to 100%) and low temperature (from 1 °C to 10 °C) in comparison with optimal conditions, humidity from 65% to 80% and temperature from 10 °C to 32 °C) daily gain of growing pigs is less than 9% to 28%, and feed costs are from 6 to 12 feed units per 1 kg of growth (instead of 4.5 to 5.5 feed units.) ; care of suckling piglets and piglets for rearing in relation to the total population from 12% to 28% higher [15].



The humidity in the building is very important and should be constantly adjusted depending on the temperature. At low humidity, animals are more tolerant of high temperatures. Pigs are most resistant to high humidity. At a temperature of 32 °C pigs weighing 100 kg equally respond to humidity of 30% and 90%.

The speed of air movement provides air exchange in the premises, enhances the cooling ability of the air. Therefore, low air velocity leads to a deterioration of the microclimate, and high can cause colds at low temperatures. For young animals it should not exceed from 0.1 to 0.2 m/s in winter and from 0.3 to 0.5 m/s in summer, for adults in winter from 0.3 to 0.5 m/s, in summer from 0.8 to 1.0 m/s [24].

## **2.2 Influence of microclimate parameters in piggeries on animal life**

The most important indicators of the microclimate are temperature and relative humidity. These indicators should be used to regulate the heating and ventilation system.

The pig's body is covered with a very thin wool cover. It does not actually protect against external temperature effects. Stable body temperature is maintained by a thermoregulatory system. To maintain a constant body temperature, the body expends a certain amount of energy. At the optimum temperature, these costs are minimal (Figure 1) [24].

At present, genetic companies have significantly increased the leanness of pork by reducing the thickness of subcutaneous tissue – the natural insulation of pigs, as a result of animals of modern genetics are more sensitive to lower temperatures [7].

According to research by the Dutch genetic company TOPIGS, an increase in indoor temperature during insemination of sows to 36 °C caused a decrease in fertility in animals of large white breed (Z-line) by 30% and in animals of Landrace (A-line) – by 15% (Figure 2) [9].

Figure 3 shows that at high relative humidity ( $\phi > 75\%$ ) pig growth decreases (20%) and feed consumption increases (40%) [15].

Dry air (relative humidity below 50%) also adversely affects the animal's body, causing irritation of the mucous membranes of the eyes, respiratory tract, decreased local immunity, increased thirst, and as a consequence, loss of appetite and absorption of nutrients [24].

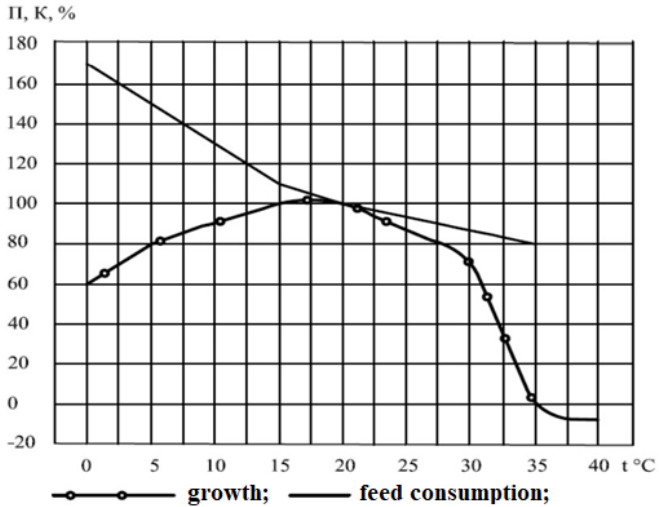

Figure 1. Influence of ambient temperature on productivity of pigs for fattening

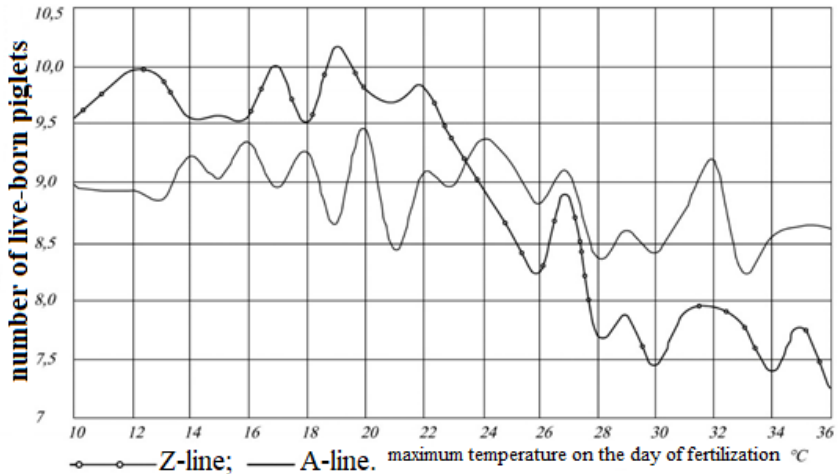

Figure 2. The effect of indoor temperature during insemination of sows on their fertility

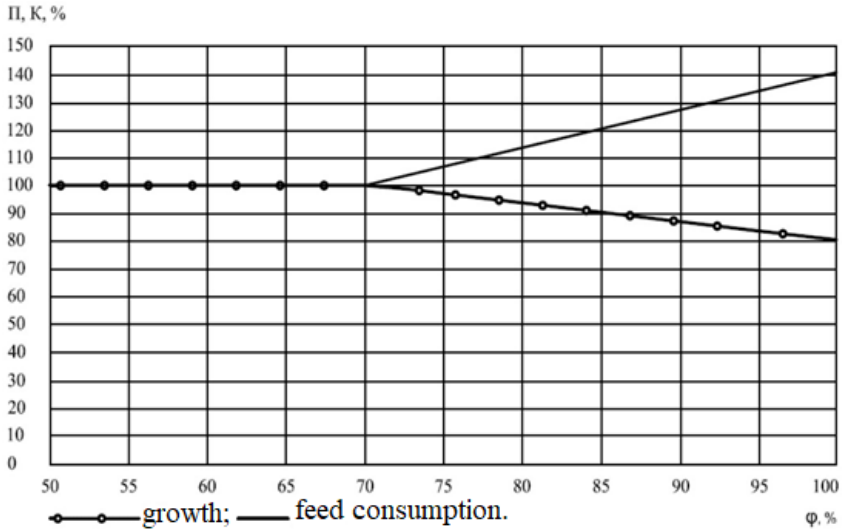

Figure 3. Influence of relative humidity on pig productivity indicators

### 2.3 Microclimate of modern pig complexes

In industrial animal husbandry, the creation of an optimal microclimate depends on many factors and is carried out through a number of compromises. Currently, there are data on the basis of which it is possible to accurately determine the environmental factors that are necessary for the manifestation of genetically determined abilities of animals. However, the provision of a thermoneutral zone is associated with large investments, high energy prices and has recently required increasing operating costs. As long as there are no significant changes in pricing, instead of forming a thermoneutral zone, it is advisable to create an optimal productive environment, which is a compromise between high production costs and quantity and quality of livestock products. Given that the size of investments and operating costs can change significantly in a short time, the characteristics of the optimal productive environment microclimatic conditions also can not remain unchanged, even given the fact that the requirements of animals to their environment do not change during for a long time [14; 15].

Modern climate control systems in pig farms include: climate control computers, sensors of temperature, humidity and gassiness, fans, humidifiers. At the heart of the microclimate system is the computer that controls all mechanisms. The computer continuously controls the fans, changing their performance from 0 to 100%, while providing greater ventilation resistance to changes in atmospheric pressure and less sensitivity to winds. This allows you to ensure an optimal indoor climate and is cost effective. It also uses non-automatic exhaust devices (roof shafts of various configurations; mines that extract air from manure ducts) and supply devices (roof mines, wall and ceiling valves, valves, windows [13].

The choice of heating system is associated with the availability of certain energy resources on the farm. In modern pig breeding, the most economical devices are direct combustion of fuel in the room (gas, liquid fuel) and electricity. Blown heat generators are economical. However, due to technological features, they can be successfully used only in rooms for keeping single-pregnant sows, boars and pigs for fattening. They create an intense movement of air, which is unacceptable in the room queen cells and rearing. In the latter premises, delta-tube water heating registers, finned heating ribbed pipes and water mats (or floor sections) for heating piglets lairs, which are supplied with water from a local boiler, have proved to be the best. Infrared emitters that run on electricity or natural gas are successfully used in growing rooms. [7].

#### **2.4 Microclimate system based on negative pressure ventilation system**

The most popular microclimate system today is based on a negative pressure ventilation system. Because it is easier to use and consumes less energy than any other forced ventilation system.

Microclimate system based on negative pressure ventilation system (Figure 4) – exhaust, with air flow through valves located in the walls or ceiling, which automatically open and close with a servomotor in accordance with the commands of the microclimate controller. Exhaust air from the room is carried out through the exhaust shafts located in the ceiling of the premises.

The supply valves direct the air to the central part of the room, mixing the cold air coming from outside with the heated inside before it reaches

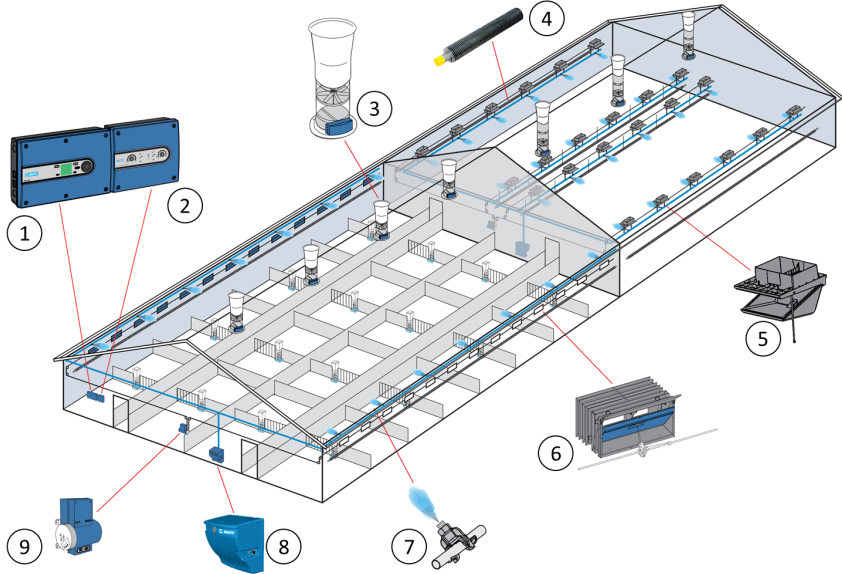

**Figure 4. Negative pressure ventilation system:**

**1 – microclimate controller; 2 – emergency opening system; 3 – exhaust shaft; 4 – pipe of the central heating system; 5 – supply valve in the ceiling; 6 – supply valve in the wall; 7 – nozzle air conditioning system; 8 – air conditioning pump; 9 – servomotor of the valve drive**

the animals. It is important that in the cold season the valves of the supply valves direct the air to the ceiling, and in the warm – to the machine seats (Figure 5). To prevent drafts, heaters must be installed under the valves.

Supply valves can also be located along the ceiling. In this case, the air enters through the roof. Installation of ceiling valves can be used on large buildings. However, because the distance from the valve to the animal holding area is small to avoid drafts, the height of the room should be greater (3 m) than when using other systems.

The negative pressure system can work in conjunction with underground ventilation. In this case, 30-50% of the exhaust air is removed through channels located in the underground space of machine tools. Underground ventilation provides good air quality, as most of the ammonia is removed

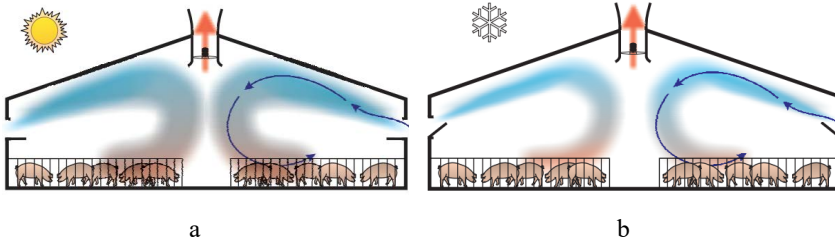

**Figure 5. Negative pressure ventilation system operation in summer (a) and winter (b)**

before it has spread throughout the room. The system is gaining popularity also because it provides good working conditions and can be easily combined with an air purification system that reduces ammonia emissions and odors.

### **2.5 Analysis and classification of technological schemes of heat utilizers for livestock premises**

In order to choose from all known technological schemes of heat utilizers the most suitable for working conditions in livestock premises, it is advisable to perform their classification [18]. This approach will allow when considering each scheme to exclude those common features that are inherent in this type and focus on distinctive features. In addition, the classification will summarize the physical properties of this type of recycler.

There are several ways to classify exhaust heat recovery units. We use the traditional classification scheme, according to which recyclers are divided into three groups [19]:

- utilizers with intermediate coolant;
- recuperators;
- regenerators.

The main feature of utilizers with intermediate coolant is the presence of a circulation circuit with or without a pump, which provides heat transfer of exhaust air to the supply (Figure 6) [3].

Utilizers with intermediate coolant can be recuperative or contact type [3]. In the latter case, the intermediate coolant comes into direct contact

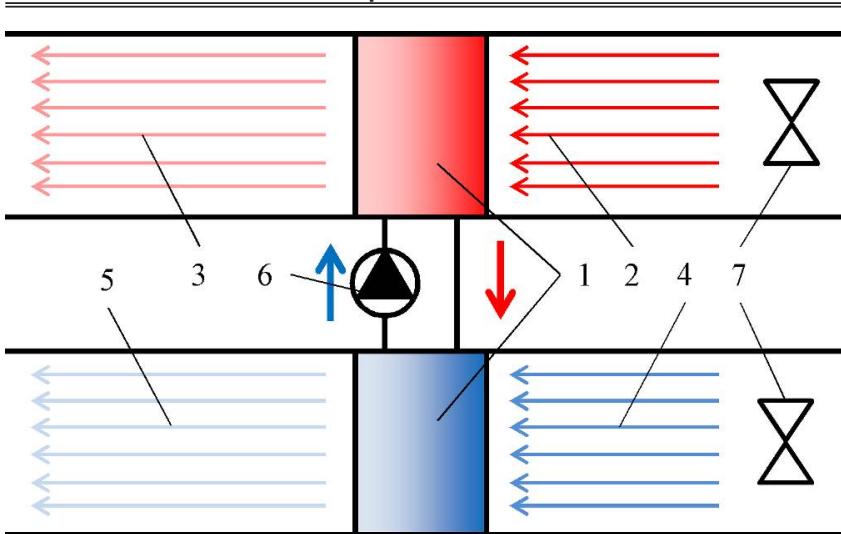

**Figure 6. Technological scheme of the recycler with intermediate coolant: 1 – heat exchange surface; directions of air movement; 2 – from the room; 3 – in the external environment; 4 – from the external environment; 5 – indoors; 6 – pump; 7 – fan**

with the heat exchange media. There are also options when in one channel the coolant is in direct contact with the medium, and in the other channel a recuperative heat exchanger is used.

Water or other liquid that does not freeze in the operating temperature range (aqueous solutions of salts, glycols, freons, etc.) can be used as an intermediate coolant.

The circulation circuit of the systems can be open or closed.

A special group of recyclers with intermediate coolant are heat exchangers made of heat pipes. The heat pipe is a chamber in which there is a liquid. One end of the pipe is washed with warm air, the other – cold. Under the action of the temperature difference at the ends of the tube is evaporation and condensation of the working fluid, which provides heat transfer. Heat exchangers made of heat pipes can be of the gravitational type with the return of the working fluid by gravity (thermosyphons) and wick, in which there is a capillary effect [21].

This method of heat utilization provides air exchange without mixing heat exchange flows, which eliminates the possibility of harmful impurities from the exhaust air into the supply air, and is recommended for use in the feasibility study for any type of premises, especially with significant distance of supply and exhaust ducts [4].

The limited use of heat recovery units with an intermediate transfer medium is due to the need to use pumps for the circulation of the coolant, which are of low reliability and require additional energy costs. In addition, heat exchange units are made of metals that in an aggressive environment of livestock and poultry premises due to corrosion quickly lose their tightness and fail, and therefore have a service life of not more than 3-4 years. The efficiency of such types of utilizers is 60-70% [13].

Switching regenerators are used in exhaust air heat recovery plants (Figure 7). In such utilizers the nozzle is motionless and is consistently washed by warm and cold air. Foil, technical cardboard, gravel, etc. are used as the material of the nozzle.

Known rotating regenerative heat exchangers in which heat transfer is carried out by the accumulating mass, which passes successively through the flows of cooling air and heated air [22]. Regenerative rotating heat exchangers are non-sorption and sorption (enthalpy).

In sorption regenerators, the heat exchange surface is covered with a layer of sorbent (lithium chloride, etc.), which absorbs moisture from the exhaust air and transfers it as a result of the process of desorption of supply air.

Regenerative rotary heat recovery units with small dimensions have a heat recovery efficiency of up to 75-85% and are able to allow large volumes of air [13]. Such heat recovery units are used for heat recovery of ventilation emissions both in industrial facilities and in air conditioning systems of residential and office premises.

The rotors of such heat recovery units are made of anti-corrosion steel and have a high cost and metal consumption. The main disadvantage of regenerative heat recovery units is that the condensate formed during heat transfer, together with pathogenic bacteria and fungi formed on a moist surface, is transferred to the supply air [4]. In addition, with this method of heat utilization there is a partial recirculation of polluted exhaust air [23]. These factors make it necessary to increase air exchange almost twice. Therefore, in rooms with high pollution and humidity of the environment,



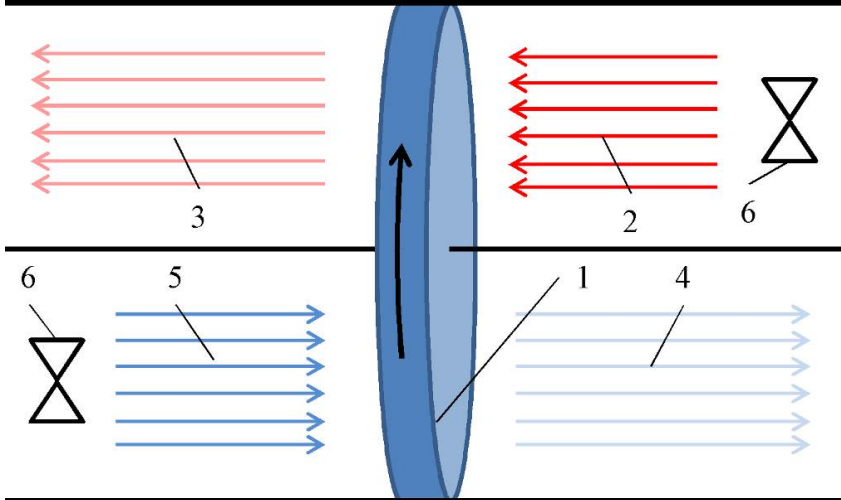
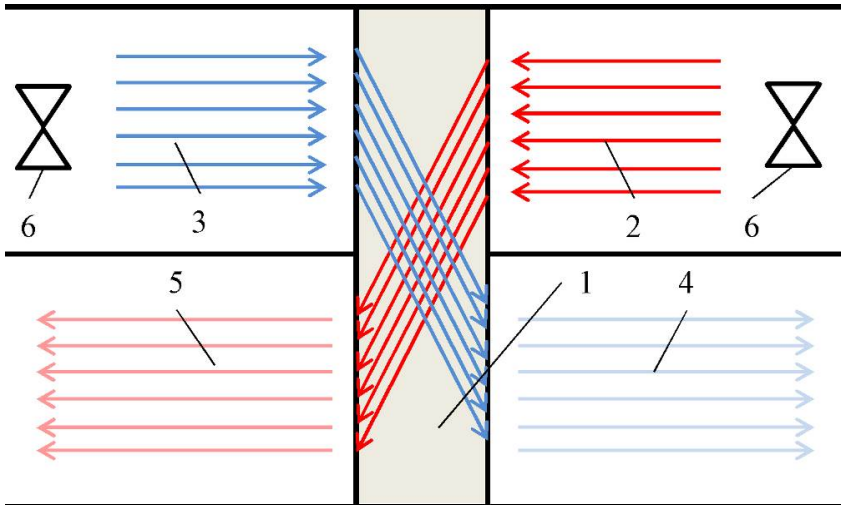

**Figure 7. Technological scheme of the regenerative recycler:**  
**1 – heat exchange regenerative surface; directions of air movement;**  
**2 – from the room; 3 – in the external environment; 4 – indoors;**  
**5 – from the external environment; 6 – fan**

which include livestock and poultry rooms, to utilize the heat of ventilation emissions to use regenerative rotary heat exchangers is impractical. In addition, technical and economic analysis [14] shows that the use of regenerative heat recovery plants in livestock and poultry facilities is not justified due to the need to increase air circulation.

In recuperative heat exchangers, heat transfer between air streams is carried out through the wall that separates them.

Many variants of design decisions of recuperators depending on conditions of their work are used. Figure 8 shows a diagram of one of the species with a cross-flow system of coolant movement through the slit channels. Such heat exchange is stationary and continuous, the structure of recuperative heat exchangers is simple, there is no collision of supply and exhaust air flows, there is dry heating of supply air, which is especially important for moisture-saturated livestock premises. where mixing of flows and partial return of the fulfilled air in the room is not allowed [20].



**Figure 8. Technological scheme of the recuperator recycler:**

- 1 – heat exchange regenerative surface; directions of air movement;  
 2 – from the room; 3 – from the external environment;  
 4 – indoors; 5 – in the external environment; 6 – fan**

Depending on the material from which they are made, recuperators can be metal, glass, cardboard, plastic, etc.

According to the direction of air flow, recuperative plate direct-surface heat utilizers are divided into direct-flow, counter-current and cross-flow. The advantages of recuperative direct-surface heat utilizers include a relatively large area of the heat exchange surface with small dimensions, high thermal performance, and simplicity of design makes them reliable and durable. The efficiency of heat utilization in recuperative plate heat recovery plants reaches 80-90% [13]. Therefore, for heat utilization in the systems of providing normative parameters of the air environment of livestock premises, the most promising are recuperative heat utilizers made of polymeric materials that are resistant to moisture and chemically active impurities.

### 3. Substantiation of geometry of location of holes in the air conductor of the microclimate provision system

#### 3.1 Analytical substantiation of the geometry of the location of the holes

Consider the calculation scheme for determining the geometry of the location of the holes in the air duct of the microclimate system (Figure 9). The axis of the air duct with the origin in the center of its end section is selected as the abscissa axis. The air duct has a length  $L$ , along which there are  $n$  holes of the same plane  $\sigma$ . The air flow rate at the beginning of the duct is  $v_n$ . It is necessary to establish how the distance between the holes changes along the length of the air duct to ensure uniform distribution of air through the holes.

Number all the holes against the movement of air flow and make cross sections for each hole.

The flow rate of air passing through the  $i$ -th hole is determined according to Torricelli's formula:

$$w_i = \phi \sqrt{\frac{2}{\rho} \Delta p_i}, \quad (1)$$

where  $\rho$  is the density of air,  $\text{kg/m}^3$ ;  $\Delta p_i$  – pressure drop at the  $i$ -th hole, Pa;  $\phi$  – coefficient cost hole,  $\phi = 0,65$  [7].

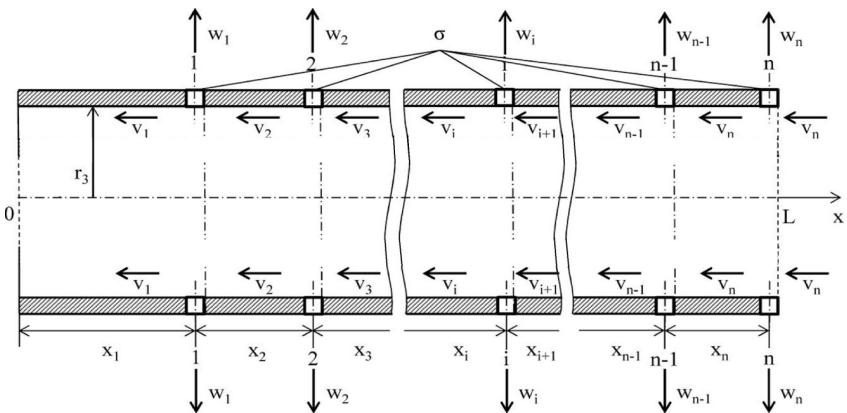

Figure 9. Calculation scheme for determining the geometry of the location of holes in the air duct of the microclimate system

From the equation (1) express  $\Delta p_i$ :

$$\Delta p_i = \frac{\rho}{2} \left( \frac{w_i}{\phi} \right)^2. \quad (2)$$

The condition for uniform air distribution is:

$$\frac{\sigma \cdot w_i}{x_i} = \frac{A \cdot v_n}{L}, \quad (3)$$

$\sigma$  – hole area, m<sup>2</sup>;

$L$  – length of air duct, m;

$x_i$  – the distance between the  $i$ -th and  $(i-1)$ -th holes, m;

$v_n$  – air flow speed at the beginning of the air duct, m/s:

$$v_n = \frac{V_0}{A}; \quad (4)$$

$V_0$  – volumetric air flow at the beginning of the air duct, m<sup>3</sup> / s;

$A$  – cross-sectional area of the air duct, m<sup>2</sup>:

$$A = \pi(r_3^2 - r_2^2); \quad (5)$$

$r_2, r_3$  – radius of air ducts, m

From the equation (3) express  $w_i$ :

$$w_i = \frac{x_i \cdot A \cdot v_n}{\sigma \cdot L}. \quad (6)$$

According to the law of conservation of mass, the sum of air flow in a given section  $i-i$  must be constant:

$$A \cdot v_{i-1} + \sigma \cdot w_i = A \cdot v_i, \quad (7)$$

$v_i$  – air flow speed on the  $i$ -th section of the air duct, m.

From the equation (7) express  $v_{i-1}$ :

$$v_{i-1} = v_i - \frac{\sigma}{A} \cdot w_i. \quad (8)$$

We write the Bernoulli equation for the  $(i-1)$  and  $i$ -th cross-section of the air duct:

$$\Delta p_i + \frac{\rho \cdot v_i^2}{2} = \Delta p_{i-1} + \frac{\rho \cdot v_{i-1}^2}{2} + \kappa \frac{x_{i-1}}{d_e} \frac{\rho \cdot v_{i-1}^2}{2} + 2 \cdot \alpha \cdot \frac{\rho}{2} (v_i - v_{i-1})^2, \quad (9)$$

where  $d_e = 2(r_3 - r_2)$  – effective diameter, m;

$\kappa$  – coefficient of friction resistance,  $\kappa = 0,01717$  [14];

$\alpha$  – coefficient mitigation factor  $\alpha = 0,4$ .

Substituting (2), (6), (8) in equation (9) and expressing xi we obtain:

$$x_i = \frac{L\phi^2\sigma^2v_i(\kappa x_{i-1} + d_e)}{v_n(\phi^2\sigma^2(\kappa x_{i-1} + d_e + 2\alpha d_e) - A^2d_e)} - \frac{\sqrt{L^2\phi^4\sigma^4v_i^2(\kappa x_{i-1} + d_e)^2 - (L^2\kappa\phi^2\sigma^2v_i^2x_{i-1} + A^2v_n^2d_e x_{i-1}^2)(\phi^2\sigma^2(\kappa x_{i-1} + d_e + 2\alpha d_e) - A^2d_e)}}{v_n(\phi^2\sigma^2(\kappa x_{i-1} + d_e + 2\alpha d_e) - A^2d_e)} \quad (10)$$

Dependence (10) connects the distance  $x_i$  with the previous distance  $x_{i-1}$  and the air flow rate on the  $i$ -th section of the air duct  $v_i$ .

To determine the distance  $x_i$ , speed  $w_i$ , the area of the holes  $\sigma$  and their number  $n$  we will make a technique consisting of the following steps:

1. Setting parameters  $L, \varphi, \alpha, \kappa, d_e, v_n, A, w_1, v_1$ .
2. Setting the step of varying the area of the holes  $\sigma = 0.001 \cdot j$ , where  $j$  – hole number.
3. Distance calculation  $x_i$  according to the formula (10), where  $i$  – hole number.
4. Distance calculation  $w_i$  according to the formula (6).
5. Calculation of the sum of distances  $L_{calc} = \sum_{i=1}^n x_i$ .
6. Fulfillment of the condition: if the sum of the distances  $L_{calc} > L$ , then the effect of item 7 is performed, otherwise item 3 is performed.
7. Determining the number of holes  $n = i$ .
8. To ensure the required convergence of the total length of the duct, we fulfill the condition: if the module is the difference between the sum of distances and the accepted length of the duct  $|L_{calc} - L| < 0,01$ , then the effect of item 9 is performed, otherwise item 2 is performed.
9. Determining the area of the holes  $\sigma_{calc} = \sigma$ .
10. Defining parameters  $n, \sigma_{calc}, x_i, w_i$ .

The developed technique and the algorithm implemented on its basis (Figure 10) are executed in the Mathematica software package.

Taking design and technological parameters ( $L = 5,8$  m;  $\varphi = 0,65$ ;  $\alpha = 0,4$ ;  $\kappa = 0,01717$  m;  $r_2 = 0,14$  m;  $r_3 = 0,2$  m;  $V_0 = 0,14$  m<sup>3</sup>/s;  $x_1 = 0,9$  m;  $v_1 = 0$  m/s) microclimate systems determined the number of holes  $n = 7$  and their area  $\sigma = 0,011$  m<sup>2</sup>, and the distribution of the distance between the holes according to Figure 2 and the air velocities through them (Figure 11).

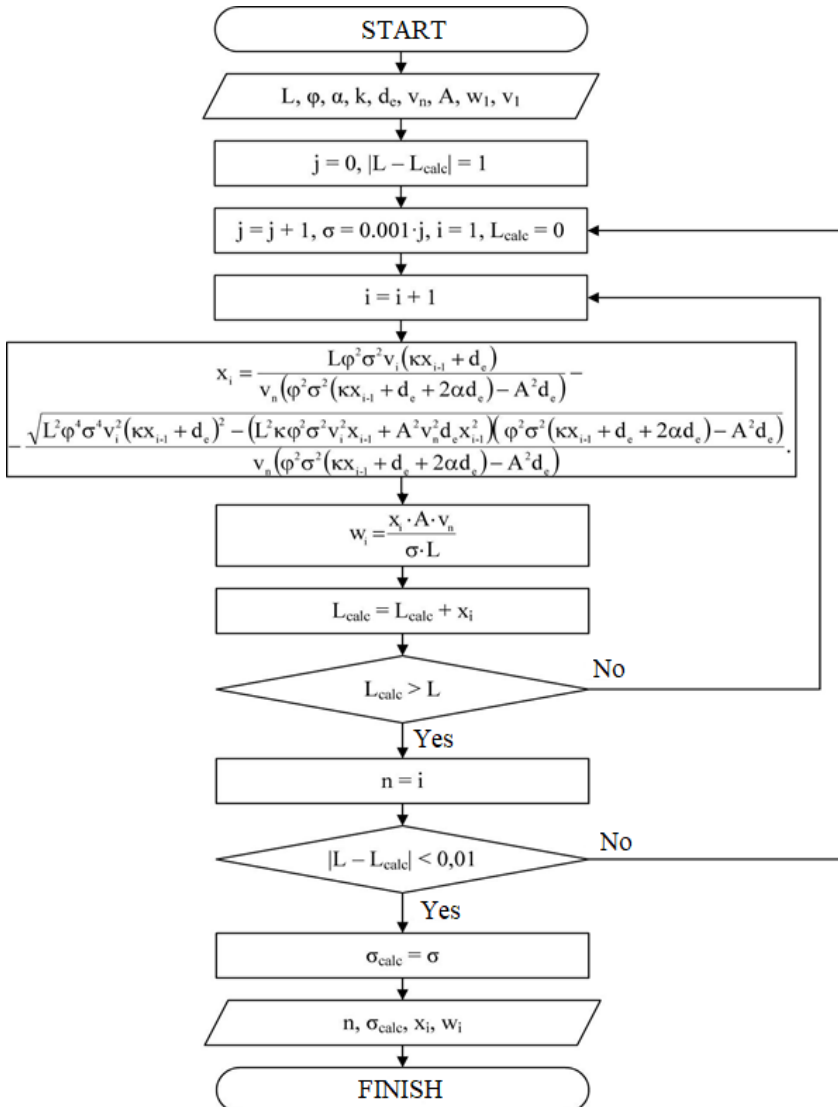

Figure 10. Algorithm for calculating the geometry of the location of holes in the air duct of the microclimate system

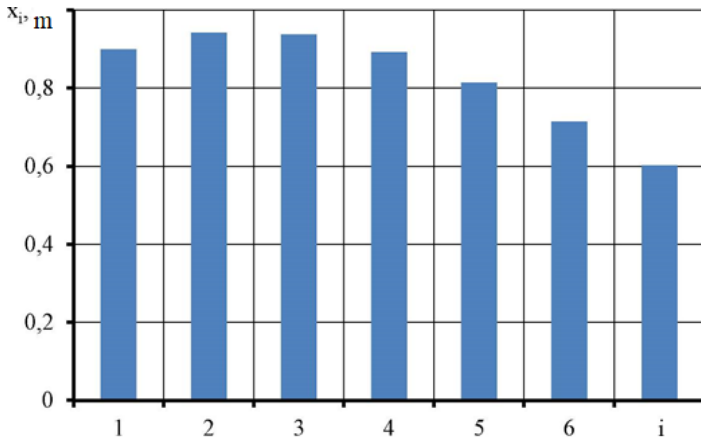

Figure 11. Distribution of the distance between the holes

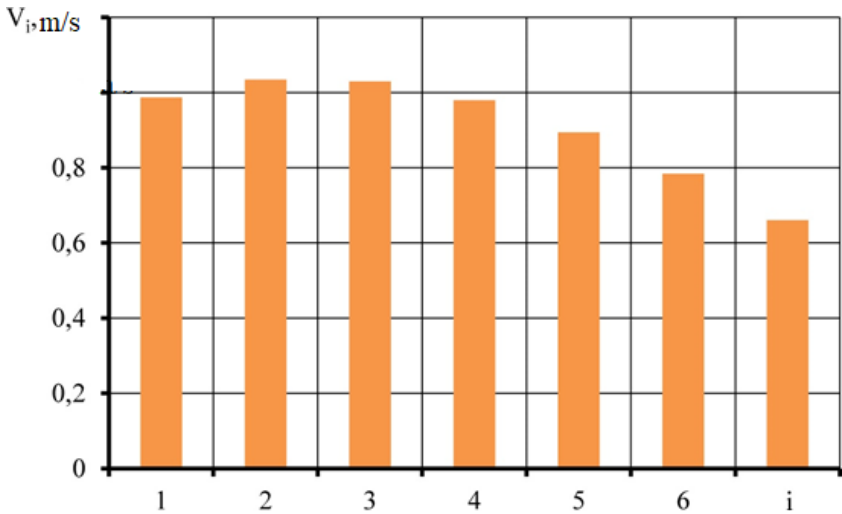

Figure 12. Distribution of air velocities through the holes

Analyzing Figure 11 in conjunction with Figure 9, it can be argued that the distance between the holes gradually decreases from 0.94 to 0.6 m in the opposite direction of air flow. However, there is a slight decrease in the distance of 0.04 m at the end of the duct, which is caused by the return flow of air, which collides with the muffled end. A similar phenomenon is observed with the distribution of air velocities through the holes.

### **3.2 Methods of experimental studies of the rational geometry of the location of holes in the air duct of the microclimate system**

Experimental studies of the rational geometry of the location of the holes in the air duct were reduced to determining the volumetric flow of air through the holes of the air duct per unit length and are calculated by the formula (3):

$$\Omega = \frac{\sigma \cdot w_i}{x_i} = \frac{V}{L}, \quad (11)$$

$w_i$  – air flow rate through the  $i$ -th hole of the air duct, m/s;  $\sigma$  – hole area, m<sup>2</sup>;  $L$  – length of air duct, m;  $x_i$  – the distance between the  $i$ -th and  $(i-1)$  -th holes, m;  $V$  – volumetric air flow at the beginning of the air duct, m<sup>3</sup>/s.

The research was carried out for two variants of the location of the air duct openings (Figure 13). If condition (3) is met, the established location of the air duct openings is effective.

The speed of air flow through the  $i$ -th hole of the air duct  $w_i$  was measured using a multifunctional measuring device “Solomat MPM 500E”. The required volume air flow at the beginning of the air duct  $V$  was set using the TD-2000 fan controllers.

The required volumetric air flow rates at the beginning of the air duct  $V$  ranged from 0.14 m<sup>3</sup>/s to 0.64 m<sup>3</sup>/s in 0.1 m<sup>3</sup>/s increments.

The general view of the universal experimental stand for the study of the location of the air duct openings is presented in Figure 14.

### **3.3 The results of studies of the rational geometry of the location of holes in the air duct**

According to the developed methodology of experimental studies of the rational geometry of the location of holes in the air duct, 6 experiments were implemented for each of the two options for the location of holes (Table 1).



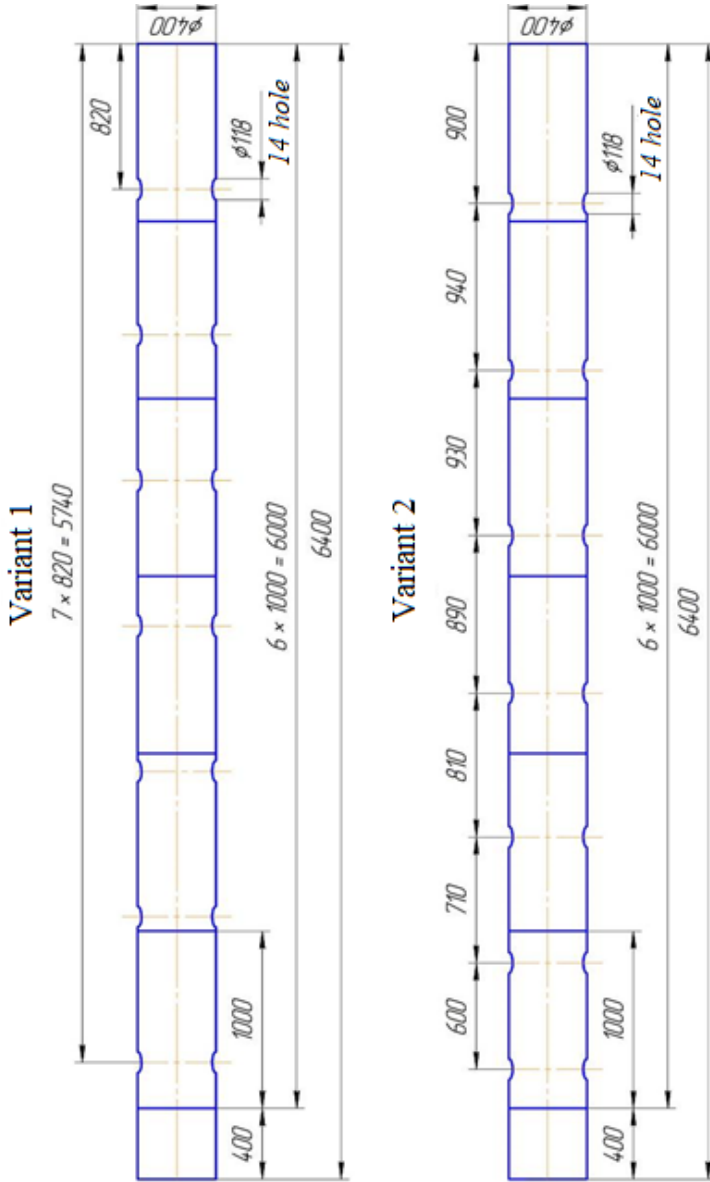

Figure 13. Options for the location of air duct openings



**Figure 14. General view of the universal experimental stand**

Graphic analysis of the obtained data (Figures 15-17) revealed that the first version of the location of the holes (which was obtained according to theoretical studies) is the most effective because it provides a uniform distribution of air flow along the length of the duct. This fact is evidenced by the constancy of the coefficient  $\Omega$ .

Figures 15-17 show that the velocity of air from the holes increases with increasing distance between them. However, at the end of the air duct, there is a decrease in air velocity due to reversible air movement. This movement occurs due to the presence of a plug at the end of the duct.

Table 1

**The results of experimental studies of the rational geometry of the location of holes in the air duct**

$V = 0,14 \text{ m}^3/\text{s}$						$V = 0,24 \text{ m}^3/\text{s}$					
Variant 1			Variant 2			Variant 1			Variant 2		
$x, \text{ m}$	$w_p, \text{ m/s}$	$\Omega$	$x, \text{ m}$	$w_p, \text{ m/s}$	$\Omega$	$x, \text{ m}$	$w_p, \text{ m/s}$	$\Omega$	$x, \text{ m}$	$w_p, \text{ m/s}$	$\Omega$
0,90	0,92	1,02	0,82	1,10	1,34	0,90	1,66	1,84	0,82	1,96	2,40
0,94	1,02	1,09	0,82	1,12	1,37	0,94	1,69	1,80	0,82	2,00	2,44
0,93	0,96	1,03	0,82	1,07	1,30	0,93	1,73	1,86	0,82	1,91	2,33
0,89	0,92	1,03	0,82	0,96	1,17	0,89	1,67	1,88	0,82	1,71	2,09
0,81	0,82	1,01	0,82	0,80	0,98	0,81	1,43	1,77	0,82	1,43	1,74
0,71	0,74	1,04	0,82	0,60	0,73	0,71	1,33	1,87	0,82	1,07	1,31
0,60	0,66	1,10	0,82	0,36	0,44	0,60	1,03	1,72	0,82	0,64	0,78

(End of Table 1)

V = 0,34 m <sup>3</sup> /s						V = 0,44 m <sup>3</sup> /s					
Variant 1			Variant 2			Variant 1			Variant 2		
x, m	w <sub>i</sub> , m/s	Ω	x, m	w <sub>i</sub> , m/s	Ω	x, m	w <sub>i</sub> , m/s	Ω	x, m	w <sub>i</sub> , m/s	Ω
0,90	2,30	2,56	0,82	2,75	3,35	0,90	2,97	3,30	0,82	3,61	4,41
0,94	2,38	2,53	0,82	2,80	3,41	0,94	3,18	3,38	0,82	3,68	4,49
0,93	2,46	2,65	0,82	2,68	3,26	0,93	3,22	3,46	0,82	3,52	4,29
0,89	2,35	2,64	0,82	2,40	2,93	0,89	2,92	3,28	0,82	3,15	3,85
0,81	2,09	2,58	0,82	2,00	2,44	0,81	2,63	3,25	0,82	2,63	3,21
0,71	1,72	2,42	0,82	1,50	1,83	0,71	2,46	3,46	0,82	1,97	2,40
0,60	1,54	2,57	0,82	0,90	1,10	0,60	2,04	3,40	0,82	1,18	1,44
V = 0,54 m <sup>3</sup> /s						V = 0,64 m <sup>3</sup> /s					
Variant 1			Variant 2			Variant 1			Variant 2		
x, m	w <sub>i</sub> , m/s	Ω	x, m	w <sub>i</sub> , m/s	Ω	x, m	w <sub>i</sub> , m/s	Ω	x, m	w <sub>i</sub> , m/s	Ω
0,90	3,50	3,89	0,82	4,40	5,37	0,90	4,47	4,97	0,82	5,26	6,42
0,94	3,78	4,02	0,82	4,48	5,46	0,94	4,43	4,71	0,82	5,36	6,54
0,93	3,71	3,99	0,82	4,28	5,22	0,93	4,62	4,97	0,82	5,12	6,24
0,89	3,57	4,01	0,82	3,84	4,68	0,89	4,24	4,76	0,82	4,59	5,60
0,81	3,33	4,11	0,82	3,20	3,90	0,81	4,00	4,94	0,82	3,83	4,67
0,71	2,91	4,10	0,82	2,40	2,93	0,71	3,49	4,92	0,82	2,87	3,50
0,60	2,54	4,23	0,82	1,44	1,76	0,60	2,93	4,88	0,82	1,72	2,10

To verify the adequacy of the algorithm for calculating the geometry of the location of the holes in the air duct, a comparison of the theoretical and experimental distribution of air velocities from the air duct holes at a given volumetric air flow rate at the beginning of the air duct. The results of this comparison are summarized in table 2.

For each value of the volumetric air flow rate at the beginning of the air duct, a correlation coefficient was calculated between the theoretical and experimental data sets, which were in the range of R = 0.92-0.98.

### 3.4 Application of the obtained results in the livestock room

According to the results of the study, a new location of ventilation openings in the room for keeping piglets for rearing on the farm FG “Delevimark” was designed. The distance between the holes is proportional to the results obtained (Figure 18).

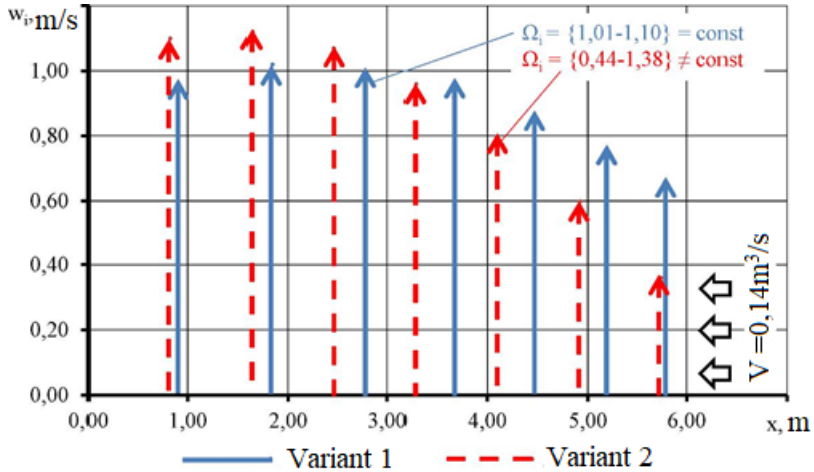

Figure 15. Distribution of air velocities from the air duct openings at a given volumetric air flow rate at the beginning of the air duct  $V = 0,14 \text{ m}^3/\text{s}$

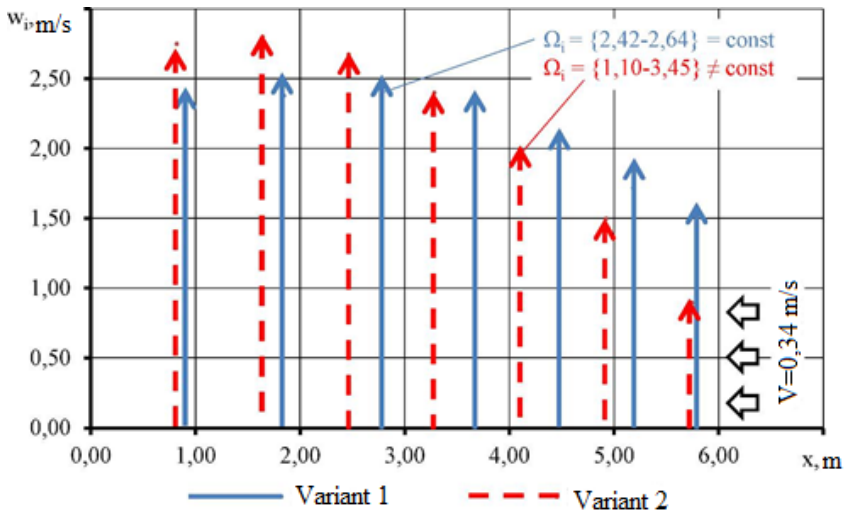
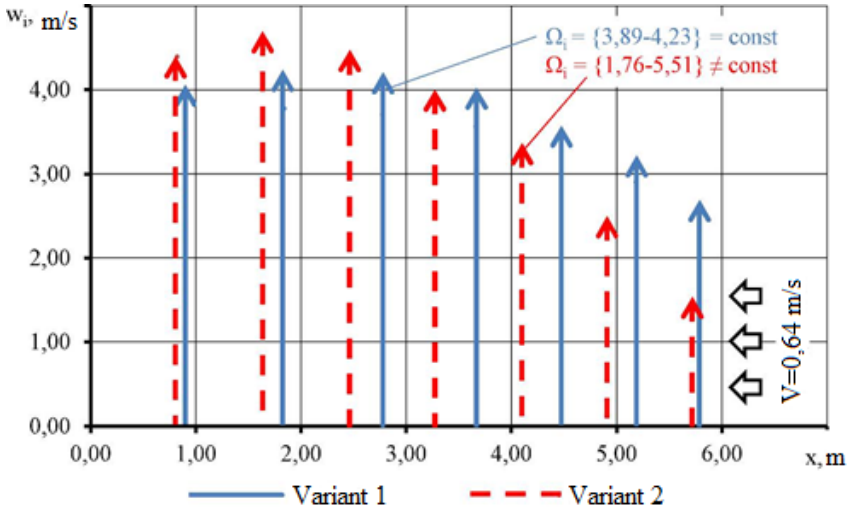

Figure 16. Distribution of air velocities from the air duct openings at a given volumetric air flow rate at the beginning of the air duct  $V = 0,34 \text{ m}^3/\text{s}$

The results of comparing the theoretical and experimental distribution of air velocities from the air duct openings at a given volumetric air flow at the beginning

№ hole	x, mm	V = 0,14 m <sup>3</sup> /s		V = 0,24 m <sup>3</sup> /s	
		w <sub>p</sub> , m/s			
		Theoretic	Experimental	Theoretic	Experimental
1	900	0,99	0,92	1,69	1,66
2	940	1,03	1,02	1,77	1,69
3	930	1,03	0,96	1,76	1,73
4	890	0,98	0,92	1,67	1,67
5	810	0,89	0,82	1,53	1,43
6	710	0,78	0,74	1,34	1,33
7	600	0,66	0,66	1,13	1,03
Correlation coefficient R		0,92		0,94	
№ hole	x, mm	V = 0,34 m <sup>3</sup> /s		V = 0,44 m <sup>3</sup> /s	
		w <sub>p</sub> , m/s			
		Theoretic	Experimental	Theoretic	Experimental
1	900	2,39	2,30	3,10	2,97
2	940	2,51	2,38	3,25	3,18
3	930	2,50	2,46	3,23	3,22
4	890	2,37	2,35	3,07	2,92
5	810	2,17	2,09	2,81	2,63
6	710	1,90	1,72	2,46	2,46
7	600	1,60	1,54	2,07	2,04
Correlation coefficient R		0,97		0,95	
№ hole	x, mm	V = 0,54 m <sup>3</sup> /s		V = 0,64 m <sup>3</sup> /s	
		w <sub>p</sub> , m/s			
		Theoretic	Experimental	Theoretic	Experimental
1	900	3,80	3,50	4,51	4,47
2	940	3,99	3,78	4,73	4,43
3	930	3,97	3,71	4,71	4,62
4	890	3,77	3,57	4,48	4,24
5	810	3,44	3,33	4,09	4,00
6	710	3,03	2,91	3,59	3,49
7	600	2,55	2,54	3,02	2,93
Correlation coefficient R		0,93		0,94	



**Figure 17. Distribution of air velocities from the air duct openings at a given volumetric air flow rate at the beginning of the air duct  $V = 0,64 \text{ m}^3/\text{s}$**

#### 4. Conclusions

1. The microclimate affects both the health of pigs and their growth and reproductive functions. Its violation leads to a decrease in the level of health of pigs, their number, respectively, to a decrease in the profitability of farms.

2. As a result of a review of studies of the influence of microclimate parameters on the physiological state of pigs, it was found that their productivity is most affected by temperature and humidity in the building for their maintenance.

3. The analysis revealed that the most popular system today is to create a microclimate based on a negative pressure ventilation system. Because it is easier to use and consumes less energy than any other forced ventilation system.

4. The analysis of technological schemes of heat utilizers showed that for heat utilization in the systems of providing normative parameters of the air environment of livestock premises the most promising are recuperative heat utilizers made of polymeric materials resistant to moisture and chemically active impurities.

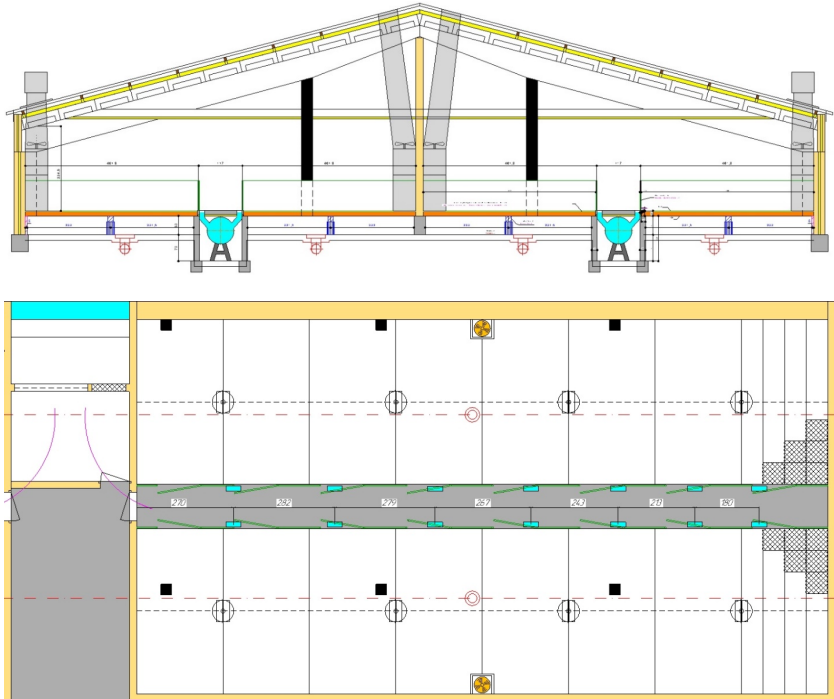

**Figure 18. The project of the section of the room for keeping piglets for fattening with a new location of ventilation holes**

5. Given the technological conditions of air in livestock premises (significant dust – up to  $3.5 \text{ mg/m}^3$ , humidity – 40-70%, the presence of high concentrations of aggressive components – ammonia 20-30  $\text{mg/m}^3$ , hydrogen sulfide – 10-15  $\text{mg/m}^3$ , carbon dioxide gas – 0.2-0.35%) and the results of the analysis of heating and cooling systems, it was found that the sanitary and hygienic and operational indicators, high energy efficiency and low cost of construction are the most suitable for ventilation systems are heat recovery units with additional heating and adiabatic cooling.

6. As a result of theoretical researches the technique is developed and on its basis the algorithm of definition of geometry of an arrangement of apertures in an air duct of system of maintenance of a microclimate for

piggeries is realized. It is established that the distance between the openings gradually decreases to a certain value in the opposite direction of air flow. However, there is a slight reduction in the distance at the end of the duct due to the backflow of air colliding with the muffled end.

7. As a result of experimental studies of the rational geometry of the location of holes in the air duct of the microclimate system for piggeries, it was found that the location of holes (obtained according to theoretical studies) is the most effective because it provides uniform distribution of air flow along the air duct.

8. It is established that the created algorithm for calculating the geometry of holes in the air duct of the microclimate system for piggeries is adequate and can be used for engineering calculations, as evidenced by the high correlation coefficient between theoretical and experimental data  $R = 0.92-0.98$ .

According to the results of the study, a new location of ventilation openings in the room for keeping piglets for rearing on the farm FG “Delevimark” was designed.

### References:

1. Yaropud V. M., Aliyev E. B. (2015) Methods of engineering calculation of heat recovery parameters for livestock premises. *Naukovyy visnyk Natsional'noho universytetu bioresursiv i pryrodovokorystannya Ukrainy. Seriya: Tekhnika ta enerhetyka APK*, vol. 212, p. 2, pp. 214–221.
2. Aliyev, E. B., Yaropud, V. M. (2015) Comparative analysis of the results of theoretical and experimental studies of the process of functioning of the heat utilizer for livestock premises. *Design, manufacture and operation of agricultural machiner*, vol. 45(2), pp. 120–124.
3. Aliyev E. B., Yaropud V. M., Belous I. M. (2020) *Substantiation of the composition of the energy-saving system of microclimate in pig farms. Vibrations in engineering and technology. Vinnytsia. VNAU*, no. 2(97), pp. 29–137.
4. Boguslavsky L. D. (1985) Reducing energy consumption during the operation of heating and ventilation systems. *Stroyizdat*, 336 p.
5. Borodin I. F., Ksyonz N. V., Shubinat T. P. (1995) Electrical zoning of the air in animal husbandry. *Mechanization and electrification of agriculture*, no. 7, p. 18.
6. Bulgakov V. M., Burlaka V. V., Kaletnik G. M. etc. (2010) Theoretical mechanics. *Handbook for practical classes. Vinnytsia: A new book*, 667 p.
7. Ventilation and air conditioning. Directory. Budvidav, 2008, pp. 119–150.
8. Departmental standards of technological design of livestock enterprises VNTP SGiP-46.-1.94. *Ministry of Agriculture of Ukraine*, 1994. 84 p.
9. Departmental standards of technological design of sheep enterprises VNTP SGiP-46.-3.98. *Ministry of Agriculture of Ukraine*, 1998. 70 p.



10. Departmental standards of technological design of facilities for procurement, storage and preparation of feed for livestock, VNTP SGiP-46.-8.94. *Ministry of Agriculture of Ukraine*, 1994. 68 p.
11. VNTP-APK-02.05. Pig enterprises (complexes, farms, small farms). *Ministry of Agrarian Policy of Ukraine*. 1995.
12. Gusev A. E., Mityukov N. V., Busygina E. L. (2012) Expediency of heat exchangers in the ventilation system. *International Journal of Experiential Education*, no. 8, pp. 63–64.
13. Ivanov O. L., Rymkevich A. A. (1980) Methodology for a comprehensive assessment of the effectiveness of the use of heat and cold recovery facilities in air conditioning systems. *Refrigeration technology*, no. 3, pp. 34–37.
14. Kaletnik H. M., Yaropud V. M. (2021) Physical and mathematical model of the ventilation system of fresh air injection in livestock premises. *Engineering, energy, transport of agro-industrial complex*, no. 3(114), pp. 4–15.
15. Kaletnik G. M., Yaropud V. M. (2021) Theoretical research of pneumatic losses of air heat exchanger of side-evaporating type of livestock premises. *Machinery & Energetics. Journal of Rural Production Research*. Kyiv, vol. 12, no. 4, pp. 35–41.
16. Prishlyak V., Yaropud V. (2015) Experimental studies of structural and technological parameters of the heat exchanger. *MOTROL. Commission of Motorization and Energetics in Agriculture*, vol. 17, no. 3, pp. 342–347.
17. Pryshlyak V. M., Yaropud V. M. (2014) Analysis and classification of technological schemes of heat utilizers for livestock premises. *Scientific and theoretical collection «Bulletin of ZhNAEU»*, vol. no. 2(45), t. 4. p. II, pp. 344–350.
18. Pryshlyak V. M., Yaropud V. M. (2014) Substantiation of constructive parameters of recuperative heat utilizers for livestock premises. *Collection of scientific works of Vinnytsia National Agrarian University. Series: Technical Sciences*, vol. 2(85), pp. 102–112.
19. Recommendations on the use of non-traditional energy sources in animal husbandry, fodder production, peasant farms and the rural residential sector. *State Scientific Institution «VIESKh»*, 2003. 45 p.
20. Yaropud V. M. (2017) Heat utilizer for livestock premises. *Vibration in engineering and technology*, no. 4(87), pp. 124–128.
21. Yaropud V. M. (2020) Research of the process of functioning and optimization of constructive-technological parameters of the three-pipe recuperator. *Engineering, energy, transport of agro-industrial complex*, no. 1(108), pp. 23–32.
22. Yaropud V. M., Aliyev E. B. (2021) The results of the survey of the state of the microclimate in the pigsty with a negative pressure ventilation system. *Engineering, energy, transport of agro-industrial complex*, no. 2(113), pp. 168–177.
23. Aliev E., Pryshliak V., Yaropud V. (2017) Research of physical and mechanical properties of oilseed crops. *MOTROL. Commission of Motorization and Energetics in Agriculture*, vol. 19, no. 3, pp. 103–108.
24. Aliev E. B., Bandura V. M., Pryshliak V. M., Yaropud V. M., Trukhanska O. O. (2018) Modeling of mechanical and technological processes of the agricultural. *INMATEH – Agricultural Engineering*, vol. 54, no. 1, pp. 95–104.

25. Gunko I., Hraniak V., Yaropud V., Kupchuk I., Rutkevych V. (2021) Optical sensor of harmful air impurity concentration. *Przegląd Elektrotechniczny*, vol. 97, no. 7, pp. 76–79.
26. Hunko I., Prishliak V., Yaropud V., Branitskyy Yu. (2017) Three-pipe concentric heat exchanger for sty. *MOTROL. Commission of Motorization and Energetics in Agriculture*, vol. 19, no. 3, pp. 33–37.
27. Kupchuk I., Yaropud V., Hraniak V., Poberezhets J., Tokarchuk O., Hontar V., Didyk A. (2021) Multicriteria compromise optimization of feed grain grinding process. *Przegląd Elektrotechniczny*, vol. 97, no. 11, pp. 179–183.
28. Poberezhets J., Chudak R., Kupchuk I., Yaropud V., Rutkevych V. (2021) Effect of probiotic supplement on nutrient digestibility and production traits on broiler chicken. *Agraarteadus*, vol. 32, no. 2, pp. 296–302.
29. Yaropud V. (2021) Analytical Study of the Automatic Ventilation System for the Intake of Polluted Air from the Pigsty. *Scientific horizons*, vol. 24, no. 3, pp. 19–27.
30. Yaropud V., Hunko I., Aliiev E., Kupchuk I. (2021) Justification of the mechatronic system for pigsty microclimate maintenance. *Agraarteadus*, vol. 32, no. 2, pp. 341–351.